

Technical data sheet

Cap nut cable gland, metric thread, silver grey, nickel-plated

Item no. 2086030



With metric connecting thread to IEC 423, robust cap-nut cable gland with large sealing area. Strain relief, wringing protection and tightness over the whole clamping area. Neoprene sealing ring. Polyamide terminal insert. With pre-mounted O sealing ring on connection thread, VDE-tested to DIN EN 50262, protection rating IP68 at 5 bar for 1 hr, max. permitted ambient temperature -20 - 100°C.

* Prices according to DEL notation.



CuZn	Brass
N	Nickel-plated

Master data

Item no.	2086030
Type	V-TEC VM20 MS
Description 1	Cable gland
Dimension	M20
Material	Brass
Material symbol	CuZn
Surface	Nickel-plated
Surface symbol	N
Smallest sales unit (VG)	25 Piece
Weight	3,14 kg/100 pc.

Technical data

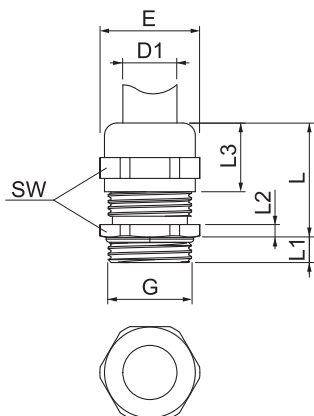

Dimension E	24,00 mm
Dimension L max.	27,00 mm
Dimension L1	6,00 mm
Dimension L2	3,50 mm
Dimension L3	16,50 mm
WAF	22,00 mm
Version	Straight
Type of seal	Sealing ring
Bend protection	<input type="checkbox"/>
Sealing range D	9,00 - 13,00 mm
explosion-proof	<input type="checkbox"/>
Flat cable threaded connection	<input type="checkbox"/>
For Ex zone	Without
Thread	M20x1,5
Thread type	Metric
Thread length	6,00 mm
Fibre-glass reinforced	<input type="checkbox"/>
Halogen-free	<input type="checkbox"/>
Installation torque	3,50 Nm
Impact category	6
Strain relief category	A

Technical data sheet

Cap nut cable gland, metric thread, silver grey, nickel-plated

Item no. 2086030



Technical data

Multiple sealing insert	<input type="checkbox"/>
With locknut	<input type="checkbox"/>
Impact-resistant	<input type="checkbox"/>
Hexagonal corner dimension	24,00 mm
Protection rating	IP68
max. permitted ambient temperature	-20,00 - 100,00 °C
Strain relief option	<input checked="" type="checkbox"/>