

# Technical data sheet

## Cap nut cable gland, PG thread, nickel-plated

Item no. 2085623



Cable gland of cap-nut design with large sealing area, and strain relief and torsion protection for high sealing demands with Pg connection thread to DIN 40430, polyamide terminal insert, sealing ring of chloroprene/nitrile rubber, with pre-mounted O ring on the connection thread.

Protection rating IP 68 at 5 bar: 1 hr, tested to VDE 0619.

"Normal" connection thread length, according to DIN 46320.

\* Prices according to DEL notation.



<b>CuZn</b>	Brass
<b>N</b>	Nickel-plated

### Master data

Item no.	2085623
Type	V-TEC PG11 MS
Description 1	Cable gland
Dimension	PG11
Material	Brass
Material symbol	CuZn
Surface	Nickel-plated
Surface symbol	N
Smallest sales unit (VG)	50 Piece
Weight	2,30 kg/100 pc.

### Technical data

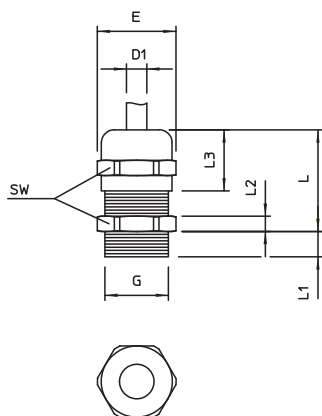

Dimension E	22,20 mm
Dimension L max.	24,00 mm
Dimension L1	6,00 mm
Dimension L2	3,00 mm
Dimension L3	15,00 mm
WAF	20,00 mm
Version	Straight
Type of seal	Sealing ring
Bend protection	<input type="checkbox"/>
Sealing range D	3,50 - 10,00 mm
Sealing range D	0,20 - 0,39 in
explosion-proof	<input type="checkbox"/>
Flat cable threaded connection	<input type="checkbox"/>
For Ex zone	Without
For Ex zone gas	Without
For Ex zone dust	Without
Thread	Pg 11
Thread type	PG
Thread length	6,00 mm
Nominal thread size	11
Fibre-glass reinforced	<input type="checkbox"/>

# Technical data sheet

Cap nut cable gland, PG thread, nickel-plated

Item no. 2085623



## Technical data

Halogen-free	<input type="checkbox"/>
Multiple sealing insert	<input type="checkbox"/>
With locknut	<input type="checkbox"/>
Impact-resistant	<input type="checkbox"/>
Protection rating	IP68
Splittable gland	<input type="checkbox"/>
max. permitted ambient temperature	-20,00 - 100,00 °C
Strain relief and wringing protection D2	4,50 - 10,00 mm
Strain relief option	<input checked="" type="checkbox"/>