

Technical data sheet

starQuick clip

Item no. 2146118



Can be arranged next to each other to size SQ-28.
 Break load: with bolt DIN 96; diameter 4.5 mm, minimum break load at 20°.
 starQuick clip Type SQ... a comprehensive programme of quality clips ideal for the use in outside areas such as parking garages, under bridges and on the exterior of steel structures. Climate conditions have no chance: the starQuick clips are made from UV weather-resistant polyamide. The starQuick clips are available in 13 different sizes with a clamping range of 10–65 mm, allowing a problem-free installation on different pipe systems. starQuick is suitable for plastic and metal pipes, as well as electrical and sanitary installations. The clips can be installed on the wall and ceiling. Mounting is amazingly fast and uncomplicated, without the use of tools. Mounting of multiple pipes is also really easy:

- By arranging the single clips.
- By using the double bracket, allowing a firm hold and spacing by heavy loads.
- A rail system allows for an open spacing and numbering of the clips.

starQuick is reliable and can support heavy loads. A patented safety system guarantees that the pipes stay where they are. The pipe is secure in the all around closed clip.



PA Polyamide

Master data

Item no.	2146118
Type	SQ-17 LGR
Description 1	starQuick clip
Dimension	16-20mm
Colour	Light grey
RAL number	7035
Material	Polyamide
Material symbol	PA
Smallest sales unit (VG)	100 Piece
Weight	0,64 kg/100 pc.

Technical data

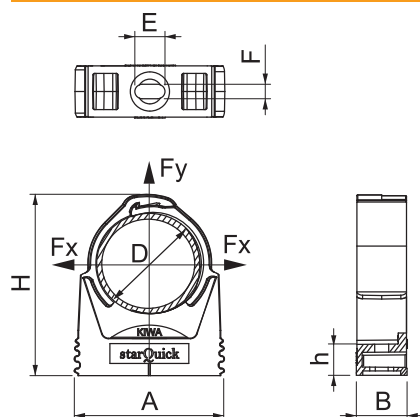

Dimension A	29,00 - 29,00 mm
Dimension B	17,00 mm
Dimension E	10,00 mm
Dimension F	4,50 mm
Dimension H	39,80 mm
Dimension h	10,50 mm
Expandable	<input checked="" type="checkbox"/>
Number of cables/pipes	1
Fastening type	Screw hole
Breaking load	0,70 kN
Flame-resistant	acc. to VDE 0471/DIN 695 Part 2-1, test temperature 650°C
Closed	<input checked="" type="checkbox"/>
Nominal size	17-19
Halogen-free	<input checked="" type="checkbox"/>
With inlay	<input type="checkbox"/>
Clip mounting	Gland hole with starQuick nut M6 or M8
Snap system	<input checked="" type="checkbox"/>
Clamping range D	16,00 - 20,00 mm
UV-resistant	<input checked="" type="checkbox"/>