

Technical data sheet

Beam clamp, with fastening hole

Item no. 1483605



Beam clamp for knocking in with fastening hole as individual fastening solution on the beam.



St	Steel
ZL	Zinc slat

Master data

Item no.	1483605
Type	BCVH 8-14
Description 1	Beam clamp
Description 2	with fastening hole
Dimension	8-14mm
Material	Steel
Material symbol	St
Surface	Zinc slat
Surface symbol	ZL
Smallest sales unit (VG)	100 Piece
Weight	1,80 kg/100 pc.

Technical data

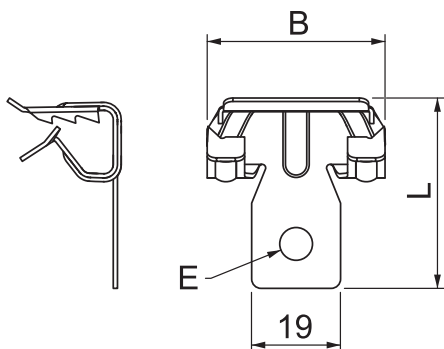

Connection type/component	Hole
Fastening type	Clamp
Fastening hole	6,50 mm
Breaking load	950,00 N
Flangethickness	8,00 - 14,00 mm
Hinge, adjustable	<input type="checkbox"/>
Hinged	<input type="checkbox"/>