

# Technical data sheet

## Beam clamp, for threaded rod

Item no. 1483665



Beam clamp for knocking in with threaded rod seat as individual fastening solution on the beam.



St	Steel
ZL	Zinc slat

### Master data

Item no.	1483665
Type	BCTR 4-8 M8
Description 1	Beam clamp
Description 2	with threaded rod M8
Dimension	4-8mm
Material	Steel
Material symbol	St
Surface	Zinc slat
Surface symbol	ZL
Smallest sales unit (VG)	50 Piece
Weight	3,10 kg/100 pc.

### Technical data

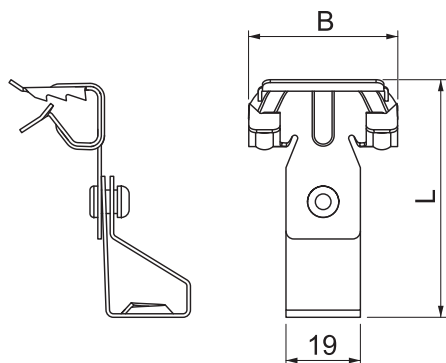

Connection type/component	Thread
Fastening type	Clamp
Breaking load	700,00 N
Flangethickness	4,00 - 8,00 mm
Thread	M8
Thread size M	8
Hinge, adjustable	<input type="checkbox"/>
Hinged	<input type="checkbox"/>