

Technical data sheet

Beam clamp, for threaded rod

Item no. 1483661



Beam clamp for knocking in with threaded rod seat as individual fastening solution on the beam.



St	Steel
ZL	Zinc slat

Master data

Item no.	1483661
Type	BCTR 4-8 M6
Description 1	Beam clamp
Description 2	with threaded rod M6
Dimension	4-8mm
Material	Steel
Material symbol	St
Surface	Zinc slat
Surface symbol	ZL
Smallest sales unit (VG)	50 Piece
Weight	3,10 kg/100 pc.

Technical data

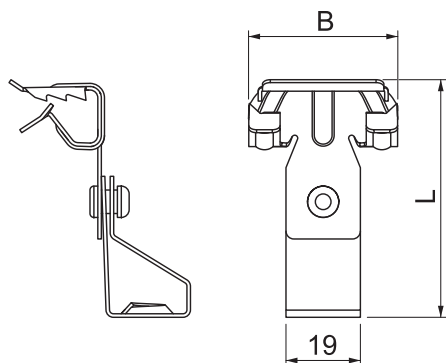

Connection type/component	Thread
Fastening type	Clamp
Breaking load	650,00 N
Flangethickness	4,00 - 8,00 mm
Thread	M6
Thread size M	6
Hinge, adjustable	<input type="checkbox"/>
Hinged	<input type="checkbox"/>