

Technical data sheet

Junction box A 18

Item no. 2000410



Protection rating IP55, rated voltage 400 V, nominal cross-section 2.5 ÷ mm², 10 entries for cable diameter 5–14 mm
8 entries for cable diameter 5–11 mm.
Clamshell.
Dimensions: 125 x 100 x 40 mm
Clear internal dimensions: 115 x 90 x 35 mm
1 cut-out tool for every 10 boxes



PE Polyethylene

Master data

Item no.	2000410
Type	A 18
Description 1	Junction box
Dimension	125x100x38
Colour	Light grey
RAL number	7035
Material	Polyethylene
Material symbol	PE
Smallest sales unit (VG)	10 Piece
Weight	6,96 kg/100 pc.

Technical data

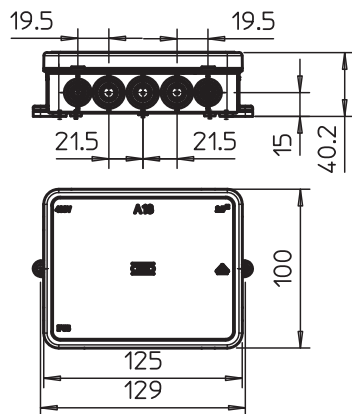

Length	125,00 mm
Width	100,00 mm
Height	40,00 mm
Clear internal dimensions	115x90x35 mm
Dimension LxWxH	125x100x40 mm
Dimension	125 x 100 x 40 mm
Expandable	<input type="checkbox"/>
No. of entries	18
Type of entry	Cable
Type of entry	Cable
Type of housing penetration	Pre-marking
Measured insulation voltage V _i	690,00 V
Equipment	Without
Cover	Not transparent
Cover fastening	Locking
Entries	10 entries for cable diameter 5–14 mm 8 entries for cable diameter 5–11 mm
Entry from rear	<input type="checkbox"/>
Explosion-tested version	<input type="checkbox"/>
Flame-resistant	acc. to VDE 0471/DIN 695 Part 2-1, test temperature 650°C
Shape	Square
Function maintenance (ETIM)	Without
For Ex zone	Without

Technical data sheet

Junction box A 18

Item no. 2000410



Technical data

For Ex zone gas	Without
For Ex zone dust	Without
Halogen-free	<input checked="" type="checkbox"/>
Max. conductor cross-section	2,50 mm ²
With screening	<input type="checkbox"/>
With cover	<input checked="" type="checkbox"/>
Installation type	Wall/ceiling mounting
Mounting type	Wall/ceiling mounting
Nominal cross section	2,50 mm ²
Nominal voltage	690,00 V
Protection rating	IP55
Sealable	<input type="checkbox"/>
max. permitted ambient temperature	-5,00 - 45,00 °C
Transparent lid	<input type="checkbox"/>
Weatherproof	<input type="checkbox"/>