

Technical data sheet

Spacer clip 733

Item no. 1362996



Spacer clip for the installation of pipes and cables on walls, ceiling and floors. With self-locking upper part. Fastening via slot. From the clip size of 20 suitable for the installation with a nail device or bolt-firing device.

Approved for the maintenance of electrical function to DIN 4102 Part 12, maintenance of electrical function classes E30 to E90 (except ALU).



A2 Stainless steel, rustproof 1.4301

Master data

Item no.	1362996
Type	ASL 733 63 A2
Description 1	Distance saddle
Description 2	with slot
Dimension	53-63mm
Material	Stainless steel, material no. 1.4301
Material symbol	A2
Smallest sales unit (VG)	20 Piece
Weight	6,24 kg/100 pc.

Technical data

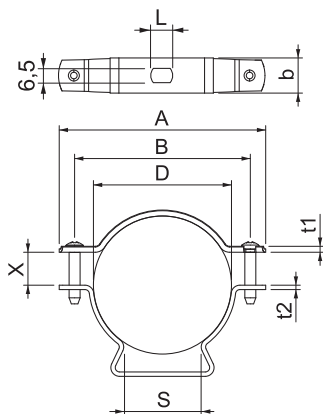

Dimension A	94,00 mm
Dimension B	80,00 mm
Dimension b	16,00 mm
Dimension D	53,00 - 63,00 mm
Dimension L	10,00 mm
Dimension s	35,30 mm
Dimension t1	1,50 mm
Dimension t2	2,00 mm
Dimension x	15,00 mm
Distance to the wall	<input checked="" type="checkbox"/>
Number of cables/pipes	1
Version	Closed
For diameter	53 ÷ 63 mm
Suitable in fire protection area	<input checked="" type="checkbox"/>
Halogen-free	<input checked="" type="checkbox"/>
Plastic coated	<input type="checkbox"/>
Clamping range D	53,00 - 63,00 mm
UV-resistant	<input checked="" type="checkbox"/>