

# Technical data sheet

## Spacer clip 733

Item no. 1362994



Spacer clip for the installation of pipes and cables on walls, ceiling and floors. With self-locking upper part. Fastening via slot. From the clip size of 20 suitable for the installation with a nail device or bolt-firing device.

Approved for the maintenance of electrical function to DIN 4102 Part 12, maintenance of electrical function classes E30 to E90 (except ALU).



A2 Stainless steel, rustproof 1.4301

### Master data

Item no.	1362994
Type	ASL 733 53 A2
Description 1	Distance saddle
Description 2	with slot
Dimension	44-53mm
Material	Stainless steel, material no. 1.4301
Material symbol	A2
Smallest sales unit (VG)	20 Piece
Weight	5,64 kg/100 pc.

### Technical data

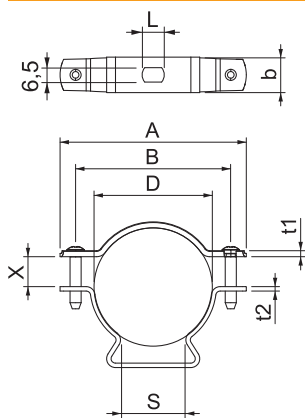

Dimension A	84,00 mm
Dimension B	70,00 mm
Dimension b	16,00 mm
Dimension D	44,00 - 53,00 mm
Dimension L	10,00 mm
Dimension s	29,50 mm
Dimension t1	1,50 mm
Dimension t2	2,00 mm
Dimension x	13,50 mm
Distance to the wall	<input checked="" type="checkbox"/>
Number of cables/pipes	1
Version	Closed
For diameter	44 ÷ 53 mm
Suitable in fire protection area	<input checked="" type="checkbox"/>
Halogen-free	<input checked="" type="checkbox"/>
Plastic coated	<input type="checkbox"/>
Clamping range D	44,00 - 53,00 mm
UV-resistant	<input checked="" type="checkbox"/>