

Technical data sheet

Spacer clip 733

Item no. 1362726

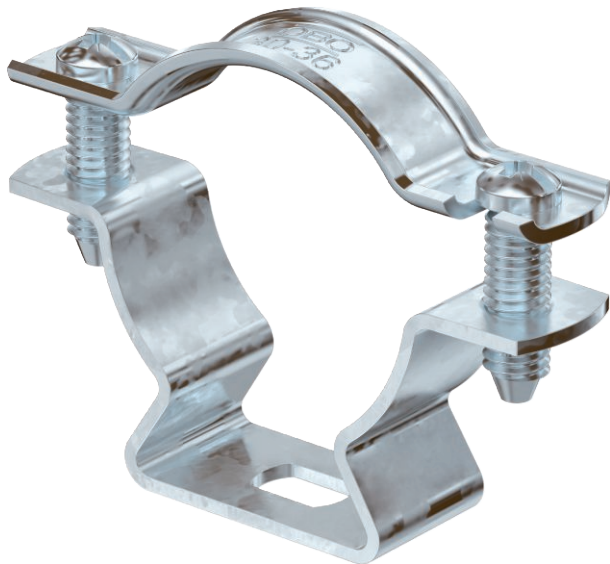

Spacer clip for the installation of pipes and cables on walls, ceiling and floors. With self-locking upper part. Fastening via slot. From the clip size of 20 suitable for the installation with a nail device or bolt-firing device.

Approved for the maintenance of electrical function to DIN 4102 Part 12, maintenance of electrical function classes E30 to E90 (except ALU).



St	Steel
FT	Hot-dip galvanised

Master data

Item no.	1362726
Type	ASL 733 36 FT
Description 1	Distance saddle
Description 2	with slot
Dimension	30-36mm
Material	Steel
Material symbol	St
Surface	Hot-dip galvanised
Surface to DIN	DIN EN ISO 1461
Surface symbol	FT
Smallest sales unit (VG)	20 Piece
Weight	3,96 kg/100 pc.

Technical data

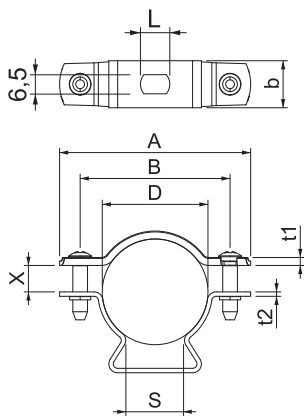

Dimension A	65,00 mm
Dimension B	51,00 mm
Dimension b	16,00 mm
Dimension D	30,00 - 36,00 mm
Dimension D	36,00 mm
Dimension L	10,00 mm
Dimension s	20,00 mm
Dimension t1	1,50 mm
Dimension t2	1,50 mm
Dimension x	9,00 mm
Distance to the wall	<input checked="" type="checkbox"/>
Number of cables/pipes	1
Version	Closed
Fastening type	Screw hole
For diameter	30 ÷ 36 mm
Suitable in fire protection area	<input checked="" type="checkbox"/>
Halogen-free	<input checked="" type="checkbox"/>
Plastic coated	<input type="checkbox"/>
Clamping range D	30,00 - 36,00 mm
UV-resistant	<input checked="" type="checkbox"/>