

Technical data sheet

Spacer clip 733

Item no. 1362712



Spacer clip for the installation of pipes and cables on walls, ceilings and floors. With self-locking cover. Fastening via slot.
Approved for the maintenance of electrical function according to DIN 4102 Part 12, maintenance of electrical function classes E 30 to E 90.



St	Steel
FT	Hot-dip galvanised

Master data

Item no.	1362712
Type	ASL 733 17 FT
Description 1	Distance saddle
Description 2	with slot
Dimension	14-17mm
Material	Steel
Material symbol	St
Surface	Hot-dip galvanised
Surface to DIN	DIN EN ISO 1461
Surface symbol	FT
Smallest sales unit (VG)	25 Piece
Weight	2,21 kg/100 pc.

Technical data

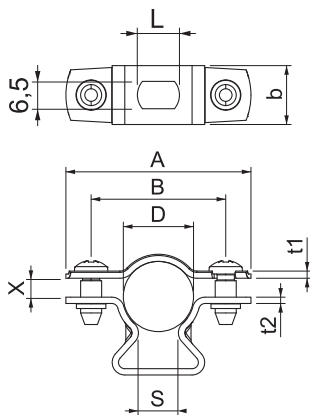

Dimension A	44,00 mm
Dimension B	32,00 mm
Dimension b	14,00 mm
Dimension D	14,00 - 17,00 mm
Dimension D	17,00 mm
Dimension L	10,00 mm
Dimension s	9,50 mm
Dimension t1	1,25 mm
Dimension t2	1,50 mm
Dimension x	4,50 mm
Distance to the wall	<input checked="" type="checkbox"/>
Number of cables/pipes	1
Version	Closed
Fastening type	Screw hole
For diameter	14 - 17 mm
Suitable in fire protection area	<input type="checkbox"/>
Halogen-free	<input checked="" type="checkbox"/>
Plastic coated	<input type="checkbox"/>
Material thickness	1,50 mm
Clamping range D	14,00 - 17,00 mm
UV-resistant	<input checked="" type="checkbox"/>