

Technical data sheet

Spacer clip 733

Item no. 1362812



Spacer clip for the installation of pipes and cables on walls, ceilings and floors. With self-locking upper part. Fastening via slot. From the clip size of 20 suitable for installation with a nail device or bolt-firing device.

Approved for the maintenance of electrical function to DIN 4102 Part 12, maintenance of electrical function classes E30 to E90 (except ALU).



Alu Aluminium

Master data

Item no.	1362812
Type	ASL 733 17 ALU
Description 1	Distance saddle
Description 2	with slot
Dimension	14-17mm
Material	Aluminium
Material symbol	Alu
Smallest sales unit (VG)	25 Piece
Weight	1,06 kg/100 pc.

Technical data

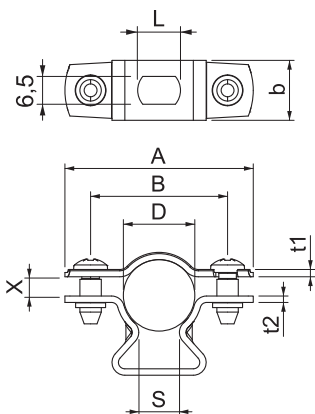

Dimension A	44,00 mm
Dimension B	32,00 mm
Dimension b	14,00 mm
Dimension D	14,00 - 17,00 mm
Dimension D	17,00 mm
Dimension L	10,00 mm
Dimension s	9,50 mm
Dimension t1	1,25 mm
Dimension t2	1,50 mm
Dimension x	4,50 mm
Distance to the wall	<input checked="" type="checkbox"/>
Number of cables/pipes	1
Version	Closed
Fastening type	Screw hole
For diameter	14 - 17 mm
Halogen-free	<input checked="" type="checkbox"/>
Plastic coated	<input type="checkbox"/>
Material thickness	1,50 mm
Clamping range D	14,00 - 17,00 mm
UV-resistant	<input checked="" type="checkbox"/>