

Technical data sheet

Spacer clip 732

Item no. 1362404



Spacer clip for the installation of pipes and cables on walls, ceilings and floors. With self-locking cover. .
Approved for the maintenance of electrical function according to DIN 4102 Part 12, maintenance of electrical function classes E 30 to E 90.



St	Steel
G	Electrogalvanised

Master data

Item no.	1362404
Type	ASG 732 6 G
Description 1	Distance saddle
Description 2	with threaded connection M6
Dimension	5-6mm
Material	Steel
Material symbol	St
Surface	Electrogalvanised
Surface to DIN	EN ISO 19598 / EN ISO 4042
Surface symbol	G
Smallest sales unit (VG)	25 Piece
Weight	1,14 kg/100 pc.

Technical data

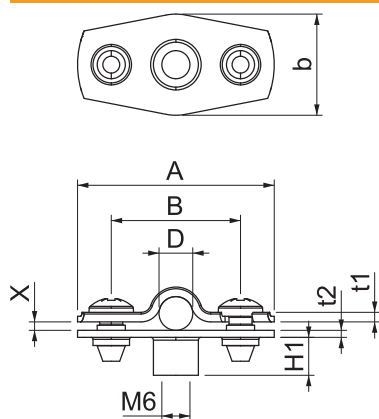

Dimension A	35,00 mm
Dimension B	23,00 mm
Dimension b	18,00 mm
Dimension D	5,00 - 6,00 mm
Dimension D	6,00 mm
Dimension H1	6,50 mm
Dimension t1	1,00 mm
Dimension t2	1,25 mm
Dimension x	1,50 mm
Distance to the wall	<input checked="" type="checkbox"/>
Number of cables/pipes	1
Version	Closed
Fastening type	Threaded connection
For diameter	5 ÷ 6 mm
Suitable in fire protection area	<input checked="" type="checkbox"/>
Halogen-free	<input checked="" type="checkbox"/>
Plastic coated	<input type="checkbox"/>
Material thickness	381,00 mm
Clamping range D	5,00 - 6,00 mm
UV-resistant	<input checked="" type="checkbox"/>