

Technical data sheet

Spacer clip 732

Item no. 1362444

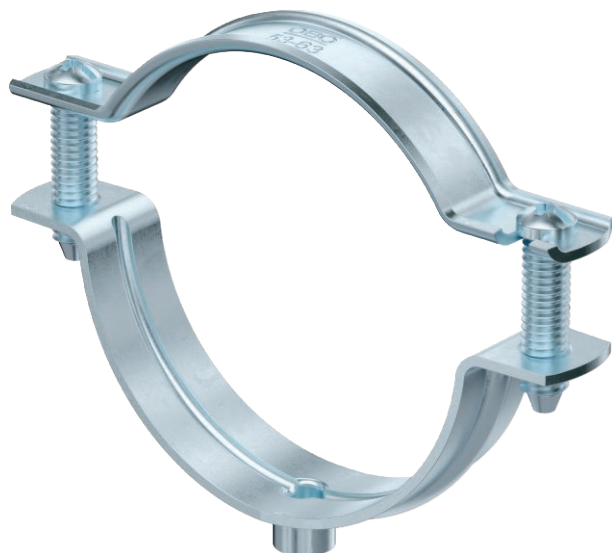

Spacer clip for the installation of pipes and cables on walls, ceilings and floors. With self-locking cover. .
Approved for the maintenance of electrical function according to DIN 4102 Part 12, maintenance of electrical function classes E 30 to E 90.



St	Steel
G	Electrogalvanised

Master data

Item no.	1362444
Type	ASG 732 63 G
Description 1	Distance saddle
Description 2	with threaded connection M6
Dimension	53-63mm
Material	Steel
Material symbol	St
Surface	Electrogalvanised
Surface to DIN	EN ISO 19598 / EN ISO 4042
Surface symbol	G
Smallest sales unit (VG)	20 Piece
Weight	5,23 kg/100 pc.

Technical data

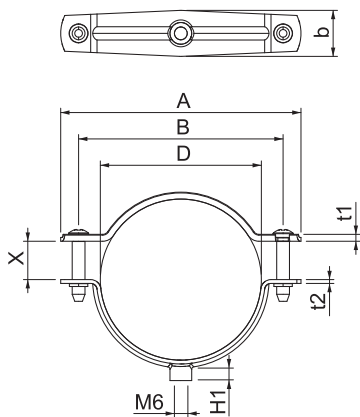

Dimension A	94,00 mm
Dimension B	80,00 mm
Dimension b	18,00 mm
Dimension D	53,00 - 63,00 mm
Dimension D	63,00 mm
Dimension H1	6,50 mm
Dimension t1	1,50 mm
Dimension t2	1,50 mm
Dimension x	15,00 mm
Distance to the wall	<input checked="" type="checkbox"/>
Number of cables/pipes	1
Version	Closed
Fastening type	Threaded connection
For diameter	53 ÷ 63 mm
Suitable in fire protection area	<input checked="" type="checkbox"/>
Halogen-free	<input checked="" type="checkbox"/>
Plastic coated	<input type="checkbox"/>
Material thickness	381,00 mm
Clamping range D	53,00 - 63,00 mm
UV-resistant	<input checked="" type="checkbox"/>