

# Technical data sheet

## Spacer clip 732

Item no. 1362428



Spacer clip for the installation of pipes and cables on walls, ceilings and floors. With self-locking cover. .  
Approved for the maintenance of electrical function according to DIN 4102 Part 12, maintenance of electrical function classes E 30 to E 90.



<b>St</b>	Steel
<b>G</b>	Electrogalvanised

### Master data

Item no.	1362428
Type	ASG 732 30 G
Description 1	Distance saddle
Description 2	with threaded connection M6
Dimension	25-30mm
Material	Steel
Material symbol	St
Surface	Electrogalvanised
Surface to DIN	EN ISO 19598 / EN ISO 4042
Surface symbol	G
Smallest sales unit (VG)	20 Piece
Weight	3,16 kg/100 pc.

### Technical data

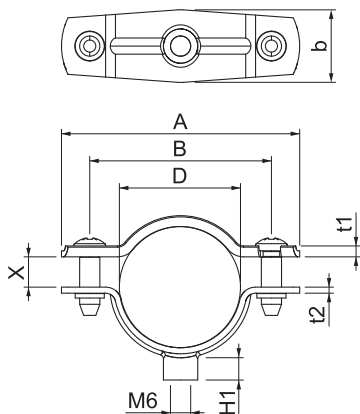

Dimension A	59,00 mm
Dimension B	45,00 mm
Dimension b	18,00 mm
Dimension D	25,00 - 30,00 mm
Dimension D	30,00 mm
Dimension H1	6,50 mm
Dimension t1	1,50 mm
Dimension t2	1,50 mm
Dimension x	7,50 mm
Distance to the wall	<input checked="" type="checkbox"/>
Number of cables/pipes	1
Version	Closed
Fastening type	Threaded connection
For diameter	25 ÷ 30 mm
Suitable in fire protection area	<input checked="" type="checkbox"/>
Halogen-free	<input checked="" type="checkbox"/>
Plastic coated	<input type="checkbox"/>
Material thickness	381,00 mm
Clamping range D	25,00 - 30,00 mm
UV-resistant	<input checked="" type="checkbox"/>