

Technical data sheet

Cable and pipe spacer clip 732 with threaded connection

Item no. 1360205



Mounting with screw-in spacer clips. Spacer clips and screw-in spacer clips are available in various materials: in V2A stainless steel, in electrogalvanised, hot-dip galvanised steel or in aluminium. Fastening can take place with bolt ties or angler anchors and Sprint screws. Depending on the design, the clips can be "shot" using a bolt-firing tool or nail device.



St Steel
GTP Electrogalvanised, transparently passivated

Master data

Item no.	1360205
Type	732 20 GTP
Description 1	Distance saddle
Description 2	with threaded connection M6
Dimension	18,5-20mm
Material	Steel
Material symbol	St
Surface	Electrogalvanised, transparently passivated
Surface symbol	GTP
Smallest sales unit (VG)	50 Piece
Weight	1,73 kg/100 pc.

Technical data

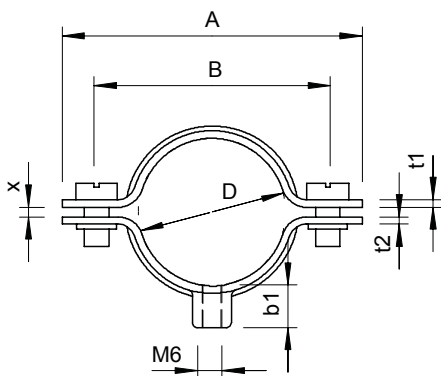

Length	46,00 mm
Dimension A	46,00 mm
Dimension B	34,00 mm
Dimension b1	8,00 mm
Dimension t1	1,00 mm
Dimension t2	1,25 mm
Dimension x	1,50 mm
Distance to the wall	<input checked="" type="checkbox"/>
Number of cables/pipes	1
Version	Closed
Fastening type	Threaded connection
For diameter	18,50 - 20,00 mm
Suitable in fire protection area	<input checked="" type="checkbox"/>
Size	M20
Halogen-free	<input checked="" type="checkbox"/>
Plastic coated	<input type="checkbox"/>
Hole size	M6 mm
Material thickness	1,00 mm
Bolt	M5 x 12
Clamping range D	18,50 - 20,00 mm
UV-resistant	<input checked="" type="checkbox"/>