

# Technical data sheet

## Fastening clip 605, medium-duty

Item no. 1018078



Two lobe fastening clips for cables and pipes.

\* Sizes 7 to 12 not suitable for bolt-firing tool.



<b>St</b>	Steel
<b>G</b>	Electrogalvanised

### Master data

Item no.	1018078
Type	605 7 G
Description 1	Fastening clip
Description 2	two lobe
Dimension	7mm
Material	Steel
Material symbol	St
Surface	Electrogalvanised
Surface to DIN	EN ISO 19598 / EN ISO 4042
Surface symbol	G
Smallest sales unit (VG)	100 Piece
Weight	0,18 kg/100 pc.

### Technical data

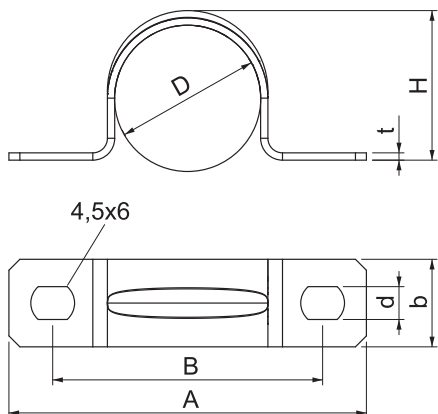

Length	32,00 mm
Width	10,00 mm
Height	6,00 mm
Dimension A	32,00 mm
Dimension B	21,00 mm
Dimension b	10,00 mm
Dimension D	7,00 mm
Dimension d	4,50 mm
Dimension e	6,00 mm
Dimension H	6,00 mm
Dimension t	1,00 mm
Distance to the wall	<input type="checkbox"/>
Number of cables/pipes	1
Version	Two-lobe
Fastening type	Screw hole
For diameter	7 mm
Suitable in fire protection area	<input type="checkbox"/>
Halogen-free	<input checked="" type="checkbox"/>
Plastic coated	<input type="checkbox"/>
Hole size	4,5 x 6 mm
Material thickness	1,00 mm
UV-resistant	<input checked="" type="checkbox"/>