

Technical data sheet

Fastening clip 605, medium-duty

Item no. 1018337



Two lobe fastening clips for cables and pipes.
* Sizes 7 to 12 not suitable for bolt-firing tool.



St	Steel
G	Electrogalvanised

Master data

Item no.	1018337
Type	605 32 G
Description 1	Fastening clip
Description 2	two lobe
Dimension	32mm
Material	Steel
Material symbol	St
Surface	Electrogalvanised
Surface to DIN	EN ISO 19598 / EN ISO 4042
Surface symbol	G
Smallest sales unit (VG)	100 Piece
Weight	1,26 kg/100 pc.

Technical data

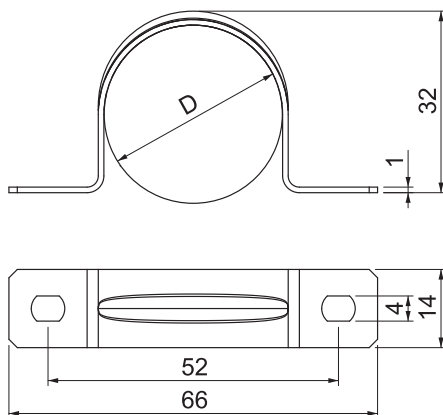

Length	66,00 mm
Width	14,00 mm
Height	30,00 mm
Dimension A	66,00 mm
Dimension B	52,00 mm
Dimension b	14,00 mm
Dimension D	32,00 mm
Dimension d	5,50 mm
Dimension e	6,00 mm
Dimension H	30,00 mm
Dimension t	1,00 mm
Distance to the wall	<input type="checkbox"/>
Number of cables/pipes	1
Version	Two-lobe
Fastening type	Screw hole
For diameter	32 mm
Suitable in fire protection area	<input type="checkbox"/>
Halogen-free	<input checked="" type="checkbox"/>
Plastic coated	<input type="checkbox"/>
Hole size	4,5 x 6 mm
Material thickness	1,00 mm
UV-resistant	<input checked="" type="checkbox"/>