

Technical data sheet

Cable tie, black, UV and weather-resistant

Item no. 2331880



Cable ties are used for quick, uncomplicated fixing or bundling of cables and pipes to cable support systems or other mounting structures.



PA Polyamide

Master data

Item no.	2331880
Type	565 4.8x300 SWUV
Description 1	Cable ties
Description 2	UV-resistant
Dimension	4,8x300mm
Colour	Black
Material	Polyamide
Material symbol	PA
Smallest sales unit (VG)	100 Piece
Weight	0,20 kg/100 pc.

Technical data

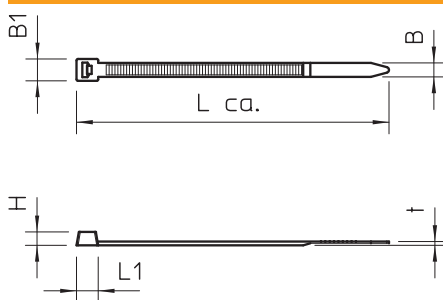

Width	4,80 mm
Length	300,00 mm
Height	1,60 mm
Dimension B	4,80 mm
Dimension L	300,00 mm
Dimension t	1,50 mm
Dimension	4,8 x 300 mm
Version	Externally toothed
Strip closure	Plastic tongue/tab
Fastening type	Without
Labelling area	Without
Halogen-free	<input checked="" type="checkbox"/>
Releasable lock	<input type="checkbox"/>
Max. bundle diameter	83,00 mm
Mounting temperature	-30,00 - 90,00 °
max. permitted ambient temperature	-30,00 - 90,00 °C
Transparent	<input type="checkbox"/>
Reflective	<input type="checkbox"/>
MIL approval	<input type="checkbox"/>
UL approval	<input checked="" type="checkbox"/>
UV-resistant	<input checked="" type="checkbox"/>
VG approval	<input type="checkbox"/>
Tensile strength	220,00 N