

# Technical data sheet

## Cable tie, black, UV and weather-resistant

Item no. 2331838



Cable ties are used for quick, uncomplicated fixing or bundling of cables and pipes to cable support systems or other mounting structures.



PA Polyamide

### Master data

Item no.	2331838
Type	565 3.6x200 SWUV
Description 1	Cable ties
Description 2	UV-resistant
Dimension	3,6x200mm
Colour	Black
Material	Polyamide
Material symbol	PA
Smallest sales unit (VG)	100 Piece
Weight	0,10 kg/100 pc.

### Technical data

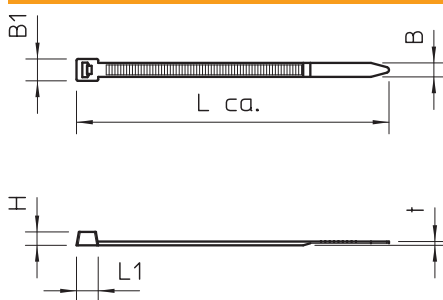

Width	3,60 mm
Length	200,00 mm
Height	1,40 mm
Dimension B	3,60 mm
Dimension L	200,00 mm
Dimension t	1,40 mm
Dimension	3,6 x 200 mm
Version	Externally toothed
Strip closure	Plastic tongue/tab
Fastening type	Without
Labelling area	Without
Halogen-free	<input checked="" type="checkbox"/>
Releasable lock	<input type="checkbox"/>
Max. bundle diameter	52,00 mm
Mounting temperature	-30,00 - 90,00 °
max. permitted ambient temperature	-30,00 - 90,00 °C
Transparent	<input type="checkbox"/>
Reflective	<input type="checkbox"/>
MIL approval	<input type="checkbox"/>
UL approval	<input checked="" type="checkbox"/>
UV-resistant	<input checked="" type="checkbox"/>
VG approval	<input type="checkbox"/>
Tensile strength	180,00 N