

Technical data sheet

Cable tie, black, UV and weather-resistant

Item no. 2331802



Cable ties are used for quick, uncomplicated fixing or bundling of cables and pipes to cable support systems or other mounting structures.



PA Polyamide

Master data

Item no.	2331802
Type	565 2.5x75 SWUV
Description 1	Cable ties
Description 2	UV-resistant
Dimension	2,4x75mm
Colour	Black
Material	Polyamide
Material symbol	PA
Smallest sales unit (VG)	100 Piece
Weight	0,02 kg/100 pc.

Technical data

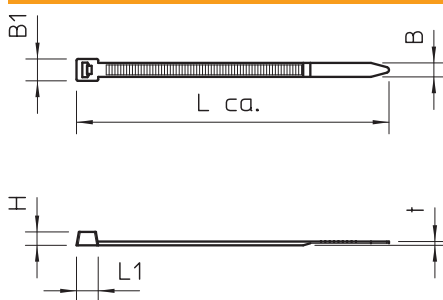

Width	2,50 mm
Length	75,00 mm
Height	1,00 mm
Dimension B	2,50 mm
Dimension L	75,00 mm
Dimension t	1,00 mm
Dimension	2,5 x 75 mm
Version	Externally toothed
Strip closure	Plastic tongue/tab
Fastening type	Without
Labelling area	Without
Halogen-free	<input checked="" type="checkbox"/>
Releasable lock	<input type="checkbox"/>
Max. bundle diameter	15,00 mm
Mounting temperature	-30,00 - 90,00 °
max. permitted ambient temperature	-30,00 - 90,00 °C
Transparent	<input type="checkbox"/>
Reflective	<input type="checkbox"/>
MIL approval	<input type="checkbox"/>
UL approval	<input checked="" type="checkbox"/>
UV-resistant	<input checked="" type="checkbox"/>
VG approval	<input type="checkbox"/>
Tensile strength	80,00 N