

Technical data sheet

Quick pipe T piece, pure white

Item no. 2153998



The Quick pipe T pieces are VDE-tested and consist of two interconnectable half shells, which can be closed around the Quick pipe.



PVC Polyvinylchloride

Master data

Item no.	2153998
Type	2953 T M32 RW
Description 1	Quick pipe T piece
Dimension	M32
Colour	Pure white
RAL number	9010
Material	Polyvinylchloride
Material symbol	PVC
Smallest sales unit (VG)	5 Piece
Weight	4,64 kg/100 pc.

Technical data

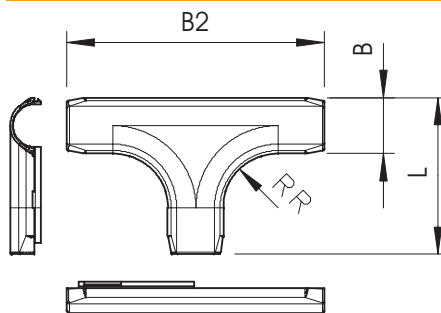

Dimension B	38,70 mm
Dimension B2	134,70 mm
Dimension L	86,70 mm
Dimension R	22,00 mm
Version	Connector
Version	Connector
Size	M32
Halogen-free	<input type="checkbox"/>
With sleeve	<input type="checkbox"/>
Polished surface	<input type="checkbox"/>
Brushed surface	<input type="checkbox"/>
max. permitted ambient temperature	0,00 - 60,00 °C