

# Technical data sheet

## Clamp clip, single, metal pressure trough

Item no. 1156152

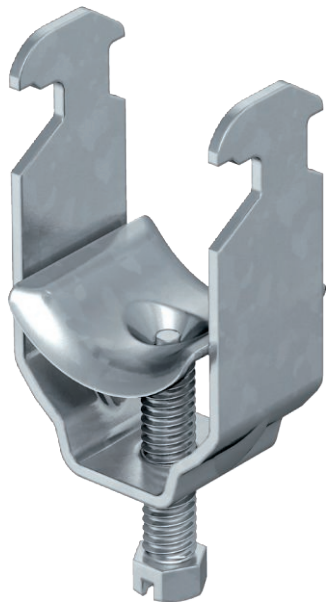

Suitable for all C profile rails with slot width 16–17 mm.  
Clip, bolt and pressure trough made of hot-dip galvanised steel.

Version with welding and/or locknuts for use under difficult circumstances and for shake protection on request.



<b>St</b>	Steel
<b>FT</b>	Hot-dip galvanised

### Master data

Item no.	1156152
Type	2056 M 90 FT
Description 1	Clamp clip
Description 2	with metal pressure sump
Dimension	82-90mm
Material	Steel
Material symbol	St
Surface	Hot-dip galvanised
Surface to DIN	DIN EN ISO 1461
Surface symbol	FT
Smallest sales unit (VG)	25 Piece
Weight	23,30 kg/100 pc.

### Technical data

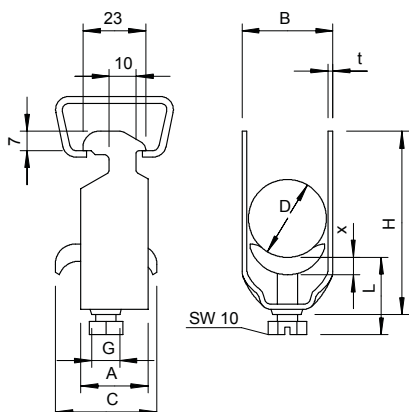

Dimension A	25,00 mm
Dimension B	97,00 mm
Dimension C	40 mm
Dimension G	M8
Dimension H	130,00 mm
Dimension L	56,00 mm
Dimension t	3,00 mm
Dimension x	5,00 mm
Number of cables/pipes	1
Max. tightening torque	5,00 Nm
for 1 cable H	130,00 mm
for 1 cable L	56,00 mm
for rail with slot width	16,00 - 17,00 mm
Halogen-free	<input type="checkbox"/>
With plastic trough	<input type="checkbox"/>
With metal trough	<input checked="" type="checkbox"/>
Mounting type	Profile rail
Impact-resistant	<input type="checkbox"/>

# Technical data sheet

Clamp clip, single, metal pressure trough

Item no. 1156152



## Technical data

Clamping range D	82,00 - 90,00 mm
Surface addition	hot galvanised
Material addition	Steel