

Technical data sheet

Clamp clip, single, metal pressure trough

Item no. 1156063

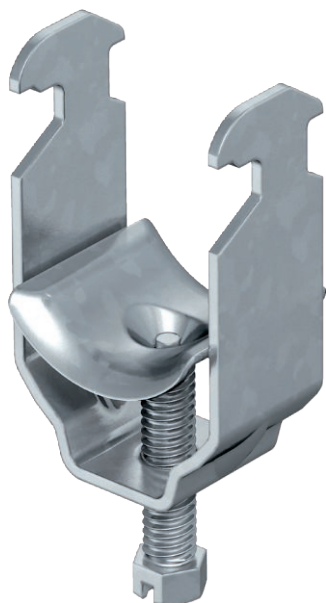

Suitable for all C profile rails with slot width 16–17 mm.
Clip, bolt and pressure trough made of hot-dip galvanised steel.

Version with welding and/or locknuts for use under difficult circumstances and for shake protection on request.



St	Steel
FT	Hot-dip galvanised

Master data

Item no.	1156063
Type	2056 M 46 FT
Description 1	Clamp clip
Description 2	with metal pressure sump
Dimension	40-46mm
Material	Steel
Material symbol	St
Surface	Hot-dip galvanised
Surface to DIN	DIN EN ISO 1461
Surface symbol	FT
Smallest sales unit (VG)	100 Piece
Weight	9,60 kg/100 pc.

Technical data

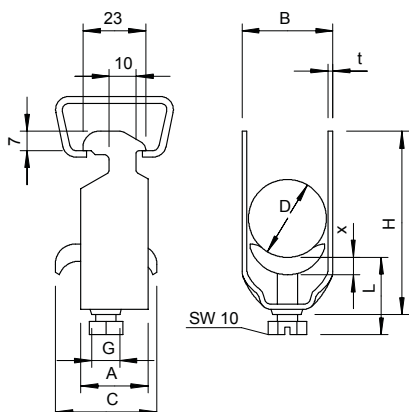

Dimension A	23,00 mm
Dimension B	51,00 mm
Dimension C	35 mm
Dimension G	M8
Dimension H	79,00 mm
Dimension L	44,00 mm
Dimension t	2,00 mm
Dimension x	5,00 mm
Number of cables/pipes	1
Max. tightening torque	5,00 Nm
for 1 cable H	79,00 mm
for 1 cable L	44,00 mm
for pipe diameter	40 mm
for rail with slot width	16,00 - 17,00 mm
Halogen-free	<input type="checkbox"/>
With plastic trough	<input type="checkbox"/>
With metal trough	<input checked="" type="checkbox"/>
Mounting type	Profile rail

Technical data sheet

Clamp clip, single, metal pressure trough

Item no. 1156063



Technical data

Impact-resistant	<input type="checkbox"/>
Clamping range D	40,00 - 46,00 mm
Surface addition	hot galvanised
Material addition	Steel