

Technical data sheet

Clamp clip, single, metal pressure trough

Item no. 1159734

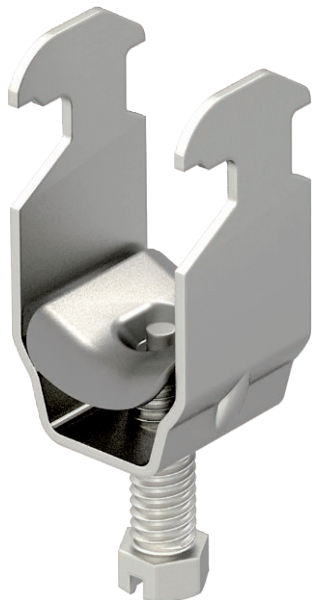

Suitable for all C profile rails with slot width 16–17 mm.
Clip, bolt and pressure trough all made of rust-proof stainless steel.



VA Stainless steel, rustproof 1.4301

2B Bright, reworked

Master data

Item no.	1159734
Type	2056 M 34 A2
Description 1	Clamp clip
Description 2	with metal pressure sump
Dimension	28-34mm
Material	Stainless steel, material no. 1.4301
Material symbol	A2
Surface	Bright, reworked
Surface symbol	2B
Smallest sales unit (VG)	25 Piece
Weight	7,70 kg/100 pc.

Technical data

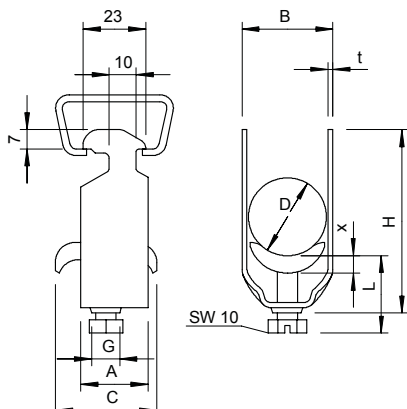

Dimension A	23,00 mm
Dimension B	39,00 mm
Dimension C	35 mm
Dimension G	M8
Dimension H	66,00 mm
Dimension L	44,00 mm
Dimension t	2,00 mm
Dimension x	5,00 mm
Number of cables/pipes	1
Max. tightening torque	5,00 Nm
for 1 cable H	66,00 mm
for 1 cable L	44,00 mm
for pipe diameter	32 mm
for rail with slot width	16,00 - 17,00 mm
Halogen-free	<input type="checkbox"/>
With plastic trough	<input type="checkbox"/>
With metal trough	<input checked="" type="checkbox"/>
Mounting type	Profile rail
Impact-resistant	<input type="checkbox"/>

Technical data sheet

Clamp clip, single, metal pressure trough

Item no. 1159734



Technical data

Clamping range D	28,00 - 34,00 mm
Surface addition	Untreated
Material addition	Rustproof steel