

Technical data sheet

Clamp clip, single, metal pressure trough

Item no. 1159716



Suitable for all C profile rails with slot width 16–17 mm.
Clip, bolt and pressure trough all made of rust-proof stainless steel.



VA Stainless steel, rustproof 1.4301

2B Bright, reworked

Master data

Item no.	1159716
Type	2056 M 16 A2
Description 1	Clamp clip
Description 2	with metal pressure sump
Dimension	12-16mm
Material	Stainless steel, material no. 1.4301
Material symbol	A2
Surface	Bright, reworked
Surface symbol	2B
Smallest sales unit (VG)	50 Piece
Weight	3,50 kg/100 pc.

Technical data

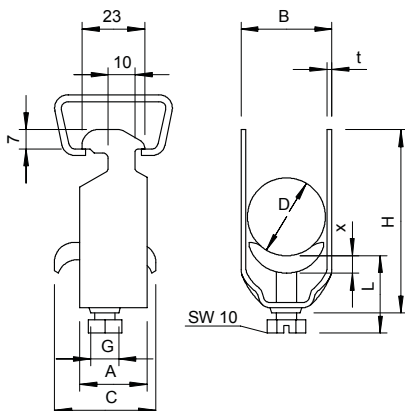

Dimension A	23,00 mm
Dimension B	20,00 mm
Dimension C	30 mm
Dimension G	M6
Dimension H	44,00 mm
Dimension L	32,50 mm
Dimension t	1,50 mm
Dimension x	3,50 mm
Number of cables/pipes	1
Max. tightening torque	3,00 Nm
for 1 cable H	44,00 mm
for 1 cable L	32,50 mm
for pipe diameter	16 mm
for rail with slot width	16,00 - 17,00 mm
Halogen-free	<input type="checkbox"/>
With plastic trough	<input type="checkbox"/>
With metal trough	<input checked="" type="checkbox"/>
Mounting type	Profile rail
Impact-resistant	<input type="checkbox"/>

Technical data sheet

Clamp clip, single, metal pressure trough

Item no. 1159716



Technical data

Clamping range D	12,00 - 16,00 mm
Surface addition	Untreated
Material addition	Rustproof steel