

Technical data sheet

Clamp clip, triple, metal pressure trough

Item no. 1156284

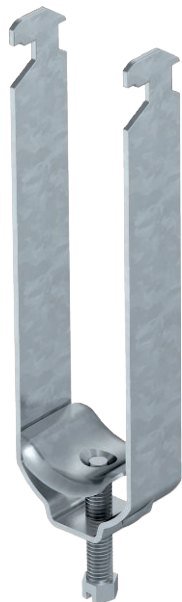

Clamp clip with metal pressure trough, triple, 22-28 mm



St	Steel
FT	Hot-dip galvanised

Master data

Item no.	1156284
Type	2056 M3 28 FT
Description 1	Clamp clip
Description 2	metal pressure sump, triple
Dimension	22-28mm
Material	Steel
Material symbol	St
Surface	Hot-dip galvanised
Surface to DIN	DIN EN ISO 1461
Surface symbol	FT
Smallest sales unit (VG)	50 Piece
Weight	9,50 kg/100 pc.

Technical data

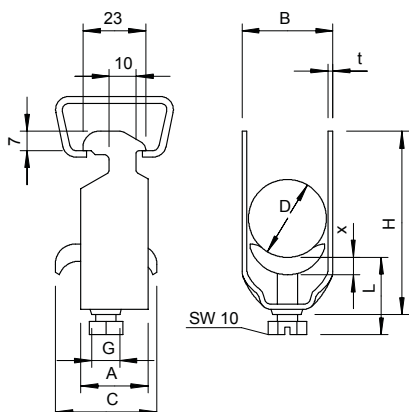

Dimension A	23,00 mm
Dimension B	33,00 mm
Dimension C	34 mm
Dimension G	M6
Dimension H	121,00 mm
Dimension L	47,00 mm
Dimension t	2,00 mm
Dimension x	5,00 mm
Number of cables/pipes	3
Max. tightening torque	3,00 Nm
for pipe diameter	25 mm
for rail with slot width	16,00 - 17,00 mm
Halogen-free	<input type="checkbox"/>
With plastic trough	<input type="checkbox"/>
With metal trough	<input checked="" type="checkbox"/>
Mounting type	Profile rail
Impact-resistant	<input type="checkbox"/>
Clamping range D	22,00 - 28,00 mm

Technical data sheet

Clamp clip, triple, metal pressure trough

Item no. 1156284



Technical data

Surface addition	hot galvanised
Material addition	Steel