

# Technical data sheet

## Clamp clip, hammer-head base, 3x single-wire connection

Item no. 1174606



Clip element, bolt and lock plate made of hot-dip galvanised steel, pressure and counter-trough made of polypropylene, halogen-free, light grey RAL 7035. Delivered complete with lock plate and counter-troughs.

The clamp clips 2056/E are used for systematic routing of single-wire cables in rotary current networks. As, with this routing type, the magnetic fields counteract each other, no heating is to be feared and steel clips can be used.

2056/E is suitable for all profile rails of 16–17 mm slot width.



- St** Steel
- FT** Hot-dip galvanised

### Master data

Item no.	1174606
Type	2056 E 31 FT
Description 1	Clamp clip
Description 2	for 3 single-wire cables
Dimension	28-31mm
Material	Steel
Material symbol	St
Surface	Hot-dip galvanised
Surface to DIN	DIN EN ISO 1461
Surface symbol	FT
Smallest sales unit (VG)	25 Piece
Weight	19,50 kg/100 pc.

### Technical data

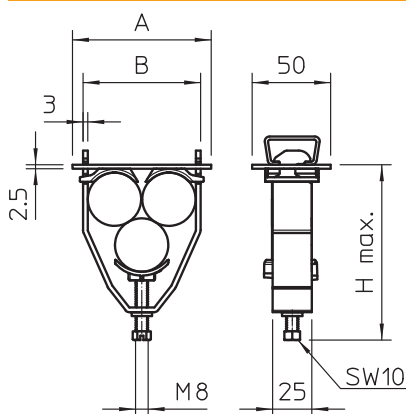

Dimension A	83,00 mm
Dimension B	69,00 mm
Dimension H	107,00 mm
Number of cables/pipes	3
Max. tightening torque	5,00 Nm
for rail with slot width	16,00 - 17,00 mm
Halogen-free	<input checked="" type="checkbox"/>
Cable diameter	28,00 - 31,00 mm
With plastic trough	<input checked="" type="checkbox"/>
With metal trough	<input type="checkbox"/>
Mounting type	Profile rail
Impact-resistant	<input type="checkbox"/>
Clamping range D	28,00 - 31,00 mm
Surface addition	hot galvanised
Material addition	Steel