

Technical data sheet

Clamp clip, single, metal pressure trough

Item no. 1158223



Suitable for all C profile rails with slot width 18 mm and 22 mm.



VA Stainless steel, rustproof 1.4571

2B Bright, reworked

Master data

Item no.	1158223
Type	2056U M 34 A4
Description 1	Clamp clip
Description 2	with metal pressure sump
Dimension	28-34mm
Material	Stainless steel, material no. 1.4571
Material symbol	A4
Surface	Bright, reworked
Surface symbol	2B
Smallest sales unit (VG)	100 Piece
Weight	6,66 kg/100 pc.

Technical data

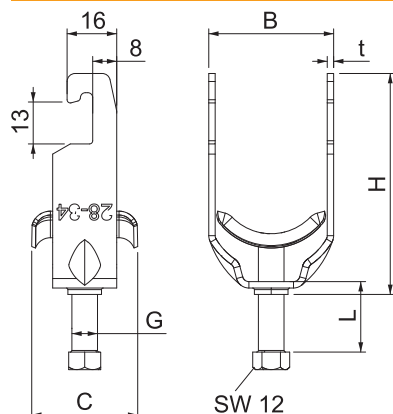

Dimension B	39,00 mm
Dimension C	34 mm
Dimension G	M8
Dimension H	69,00 mm
Dimension L	28,00 mm
Dimension t	2,00 mm
Number of cables/pipes	1
Max. tightening torque	5,00 Nm
for pipe diameter	32 mm
for rail with slot width	18,00 - 22,00 mm
Halogen-free	<input type="checkbox"/>
With plastic trough	<input type="checkbox"/>
With metal trough	<input checked="" type="checkbox"/>
Mounting type	Profile rail
Impact-resistant	<input type="checkbox"/>
Clamping range D	28,00 - 34,00 mm
Surface addition	Untreated
Material addition	Rustproof steel