

# Technical data sheet

## Series pressure clip, light grey

Item no. 2250071



Universal clip for the single fastening of cables and pipes, all sizes can be seamlessly expanded among each other, with adhesive foot, slot and for screwing to M6 thread.

To stick the polyamide clips to masonry and concrete, use Impu-Fix ribbon conductor quick adhesive, type 509.

\*Sizes 3-7 are not suitable for nail guns.



PA Polyamide

### Master data

Item no.	2250071
Type	2037 3-7 LGR
Description 1	Series pressure clip
Dimension	3-7mm
Colour	Light grey
RAL number	7035
Material	Polyamide
Material symbol	PA
Smallest sales unit (VG)	100 Piece
Weight	0,26 kg/100 pc.

### Technical data

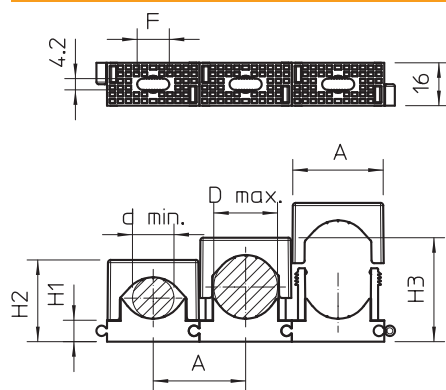

Dimension A	14,50 mm
Dimension d min.	3,00 mm
Dimension d max.	7,00 mm
Dimension F	6,00 mm
Dimension H1	7,50 mm
Dimension H2	15,50 mm
Dimension H3	19,50 mm
Expandable	<input checked="" type="checkbox"/>
Number of cables/pipes	1
Version	Closed
Fastening type	Screw hole
Halogen-free	<input checked="" type="checkbox"/>
Impact-resistant	<input type="checkbox"/>
Snap system	<input checked="" type="checkbox"/>
Clamping range D	3,00 - 7,00 mm