

Technical data sheet

Grip, metal 30

Item no. 2207140



Metal cable tidy for high mechanical stability, even in case of fire. Suitable for safe mounting above fire protection ceilings. Also approved as a cable-specific variant for the maintenance of electrical function to DIN 4102 part 12. For wall and ceiling mounting. Lock can be opened without tools. Detailed information on the approved routing variants can be found in the appropriate testing documentation.



A4	Stainless steel, rustproof 1.4571
2B	Bright, reworked

Master data

Item no.	2207140
Type	2031 M 30 A4
Description 1	Grip collecting clamp
Dimension	30x NYM3x1,5
Material	Stainless steel, material no. 1.4571
Material symbol	A4
Surface	Bright, reworked
Surface symbol	2B
Smallest sales unit (VG)	25 Piece
Weight	6,50 kg/100 pc.

Technical data

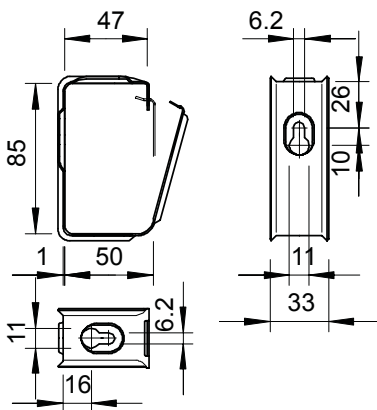

No. of conductors NYM 3 x 1.5	30
Flame-resistant version	<input type="checkbox"/>
Suitable for maintaining electrical function	<input checked="" type="checkbox"/>
Halogen-free	<input checked="" type="checkbox"/>
With anchor	<input type="checkbox"/>