

Technical data sheet

ISO nail clip 2016

Item no. 2226219



ISO nail clip, short design



PP Polypropylene

Master data

Item no.	2226219
Type	2016 40 RW
Description 1	ISO nail clip
Dimension	16mm, L40
Colour	Pure white
RAL number	9010
Material	Polypropylene
Material symbol	PP
Smallest sales unit (VG)	50 Piece
Weight	0,32 kg/100 pc.

Technical data

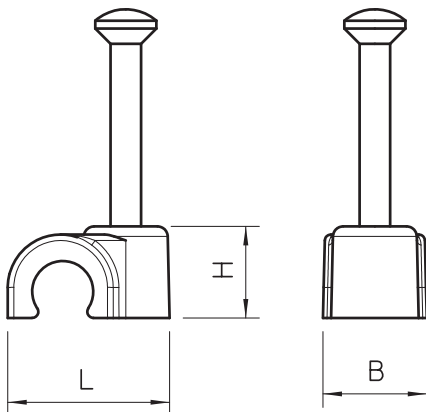

Dimension B	12,00 mm
Dimension H	20,00 mm
Dimension L	26,00 mm
For cable diameter	16,00 mm
For nail diameter	2,0x40 mm
Double clip	<input type="checkbox"/>
Hardened	<input checked="" type="checkbox"/>
Halogen-free	<input checked="" type="checkbox"/>
With nail	<input checked="" type="checkbox"/>
Nail length	40,00 mm
Impact-resistant	<input type="checkbox"/>