

# Technical data sheet

## ISO nail clip 2014

Item no. 2226111



ISO nail clip, short design



PP Polypropylene

### Master data

Item no.	2226111
Type	2014 40 RW
Description 1	ISO nail clip
Dimension	14mm, L40
Colour	Pure white
RAL number	9010
Material	Polypropylene
Material symbol	PP
Smallest sales unit (VG)	50 Piece
Weight	0,30 kg/100 pc.

### Technical data

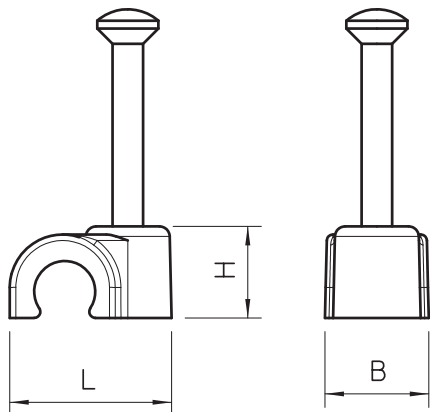

Dimension B	11,00 mm
Dimension H	18,00 mm
Dimension L	24,00 mm
For cable diameter	14,00 mm
For nail diameter	2,0x40 mm
Double clip	<input type="checkbox"/>
Hardened	<input checked="" type="checkbox"/>
Halogen-free	<input checked="" type="checkbox"/>
With nail	<input checked="" type="checkbox"/>
Nail length	40,00 mm
Impact-resistant	<input type="checkbox"/>