

Technical data sheet

ISO nail clip 2011

Item no. 2225913



ISO nail clip, short design



PP Polypropylene

Master data

Item no.	2225913
Type	2011 35 RW
Description 1	ISO nail clip
Dimension	11 mm, L35
Colour	Pure white
RAL number	9010
Material	Polypropylene
Material symbol	PP
Smallest sales unit (VG)	100 Piece
Weight	0,16 kg/100 pc.

Technical data

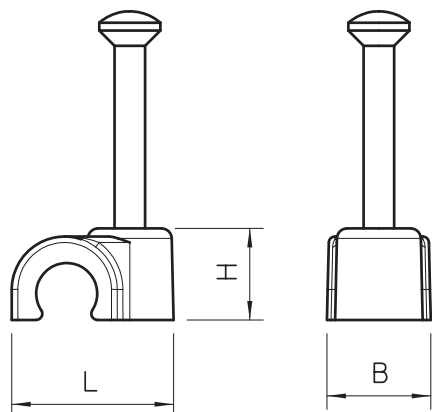

Dimension B	9,00 mm
Dimension H	14,00 mm
Dimension L	19,00 mm
For cable diameter	11,00 mm
For nail diameter	2,0x35 mm
Double clip	<input type="checkbox"/>
Hardened	<input checked="" type="checkbox"/>
Halogen-free	<input checked="" type="checkbox"/>
With nail	<input checked="" type="checkbox"/>
Nail length	35,00 mm
Impact-resistant	<input type="checkbox"/>