

Technical data sheet

ISO nail clip 2008

Item no. 2225638



ISO nail clip, short design



PP Polypropylene

Master data

Item no.	2225638
Type	2008 35 RW
Description 1	ISO nail clip
Dimension	8mm, L35
Colour	Pure white
RAL number	9010
Material	Polypropylene
Material symbol	PP
Smallest sales unit (VG)	100 Piece
Weight	0,13 kg/100 pc.

Technical data

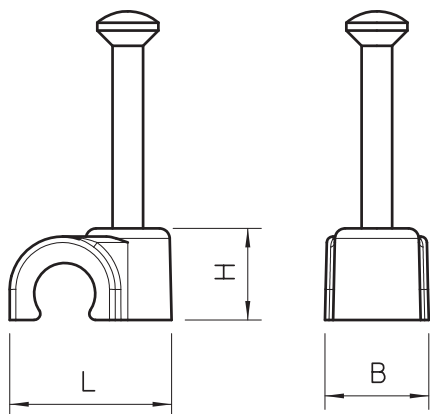

Dimension B	8,00 mm
Dimension H	10,60 mm
Dimension L	15,00 mm
For cable diameter	8,00 mm
For nail diameter	2,0x35 mm
Double clip	<input type="checkbox"/>
Hardened	<input checked="" type="checkbox"/>
Halogen-free	<input checked="" type="checkbox"/>
With nail	<input checked="" type="checkbox"/>
Nail length	35,00 mm
Impact-resistant	<input type="checkbox"/>