

Technical data sheet

ISO nail clip 2007

Item no. 2225514



ISO nail clip, short design



PP Polypropylene

Master data

Item no.	2225514
Type	2007 25 RW
Description 1	ISO nail clip
Dimension	7mm, L25
Colour	Pure white
RAL number	9010
Material	Polypropylene
Material symbol	PP
Smallest sales unit (VG)	100 Piece
Weight	0,10 kg/100 pc.

Technical data

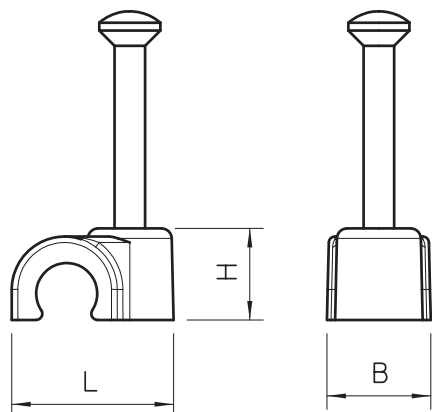

Dimension B	8,00 mm
Dimension H	9,40 mm
Dimension L	13,70 mm
For cable diameter	7,00 mm
For nail diameter	2,0x25 mm
Double clip	<input type="checkbox"/>
Hardened	<input checked="" type="checkbox"/>
Halogen-free	<input checked="" type="checkbox"/>
With nail	<input checked="" type="checkbox"/>
Nail length	25,00 mm
Impact-resistant	<input type="checkbox"/>