

# Technical data sheet

## ISO nail clip 2007

Item no. 2225506



ISO nail clip, short design



PP Polypropylene

### Master data

Item no.	2225506
Type	2007 18 RW
Description 1	ISO nail clip
Dimension	7mm, L18
Colour	Pure white
RAL number	9010
Material	Polypropylene
Material symbol	PP
Smallest sales unit (VG)	100 Piece
Weight	0,08 kg/100 pc.

### Technical data

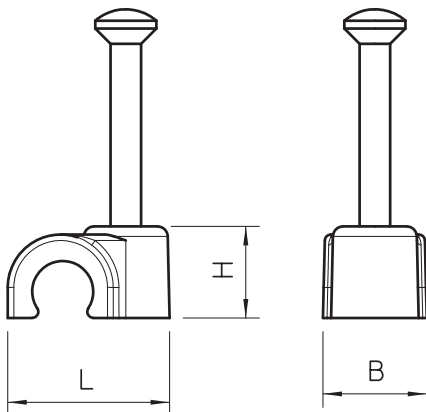

Dimension B	8,00 mm
Dimension H	9,40 mm
Dimension L	13,70 mm
For cable diameter	7,00 mm
For nail diameter	2,0x18 mm
Double clip	<input type="checkbox"/>
Hardened	<input checked="" type="checkbox"/>
Halogen-free	<input checked="" type="checkbox"/>
With nail	<input checked="" type="checkbox"/>
Nail length	18,00 mm
Impact-resistant	<input type="checkbox"/>