

Technical data sheet

ISO nail clip 2005

Item no. 2225344



ISO nail clip, short design



PP Polypropylene

Master data

Item no.	2225344
Type	2005 25 RW
Description 1	ISO nail clip
Dimension	5mm, L25
Colour	Pure white
RAL number	9010
Material	Polypropylene
Material symbol	PP
Smallest sales unit (VG)	100 Piece
Weight	0,08 kg/100 pc.

Technical data

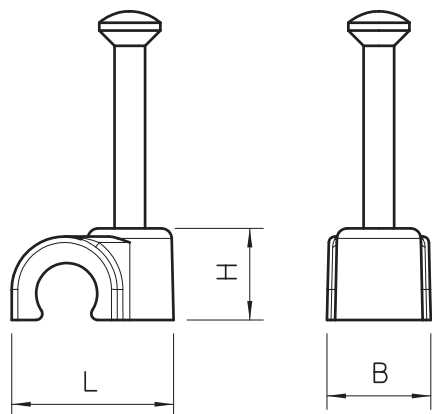

Dimension B	7,10 mm
Dimension H	7,10 mm
Dimension L	10,80 mm
For cable diameter	5,00 mm
For nail diameter	2,0x28 mm
Double clip	<input type="checkbox"/>
Hardened	<input checked="" type="checkbox"/>
Halogen-free	<input checked="" type="checkbox"/>
With nail	<input checked="" type="checkbox"/>
Nail length	25,00 mm
Impact-resistant	<input type="checkbox"/>