

Technical data sheet

Pipe end cap, splittable, metric, black

Item no. 2047971



Separable pipe end cap to slot onto metric electrical installation pipes. The separable pipe end cap can be used for repairs on existing installations according to regulations. It is not necessary to disconnect the cables, allowing quick mounting.



PE Polyethylene

Master data

Item no.	2047971
Type	129 TB M32 SW
Description 1	Pipe end sleeve, separable
Description 2	metric
Dimension	M32
Colour	Black
Material	Polyethylene
Material symbol	PE
Smallest sales unit (VG)	50 Piece
Weight	0,66 kg/100 pc.

Technical data

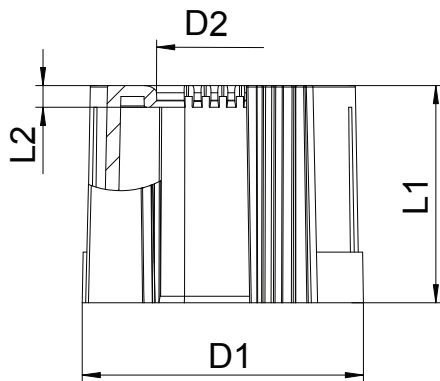

Dimension D1	36,00 mm
Dimension D2	25,40 mm
Dimension L1	30,00 mm
Dimension L2	3,00 mm
Version	Connector
For pipe diameter	32,00 mm
Size	M32
Halogen-free	<input checked="" type="checkbox"/>
Brushed surface	<input type="checkbox"/>
Polished surface	<input type="checkbox"/>