

Technical data sheet

Pipe end cap, splittable, metric, light grey

Item no. 2047839



Separable pipe end cap to slot onto metric electrical installation pipes. The separable pipe end cap can be used for repairs on existing installations according to regulations. It is not necessary to disconnect the cables, allowing quick mounting.



PE Polyethylene

Master data

Item no.	2047839
Type	129 TB M25
Description 1	Pipe end sleeve, separable
Description 2	metric
Dimension	M25
Colour	Light grey
RAL number	7035
Material	Polyethylene
Material symbol	PE
Smallest sales unit (VG)	50 Piece
Weight	0,50 kg/100 pc.

Technical data

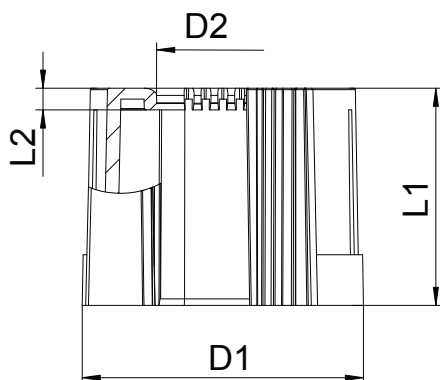

Dimension D1	30,00 mm
Dimension D2	18,40 mm
Dimension L1	30,00 mm
Dimension L2	3,00 mm
Version	Connector
For pipe diameter	25,00 mm
Size	M25
Halogen-free	<input checked="" type="checkbox"/>
Brushed surface	<input type="checkbox"/>
Polished surface	<input type="checkbox"/>