

Technical data sheet

Height compensation set for UZD350-3 with height
165–220 mm
Item no. 7410164

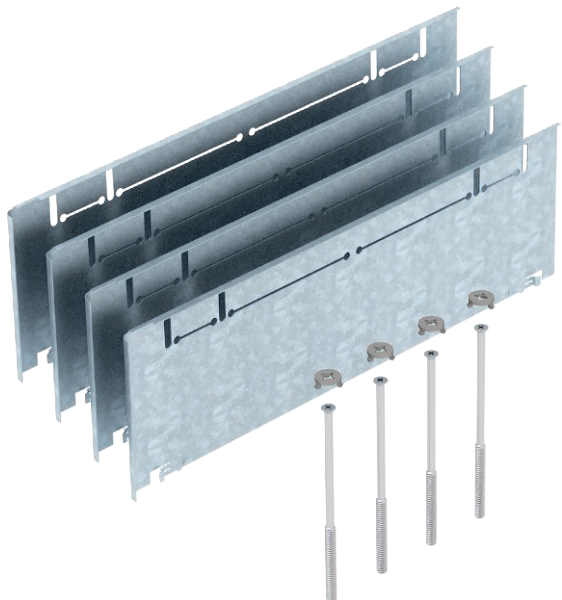

Height compensation set for underfloor boxes UZD350-3 with a construction height of 165 to 220 mm for construction stacking of the UZD, consisting of four fall plates, four height adjustment screws and four rotary locks.



- St** Steel
- FS** Strip galvanised

Master data

Item no.	7410164
Type	ASH350-3 215270
Description 1	Height construction set
Description 2	for screed height 215+55mm
Material	Steel
Material symbol	St
Surface	Strip galvanised
Surface to DIN	DIN EN 10346
Surface symbol	FS
Smallest sales unit (VG)	1 Piece
Weight	105,00 kg/100 pc.

Technical data

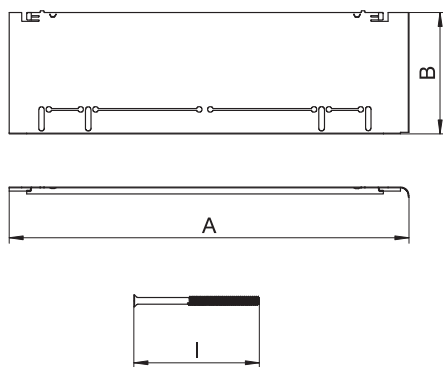

Dimension A	430,00 mm
Dimension B	80,00 mm
Dimension I	212,00 mm
Version	Other
Lowerable to be flushfloor	<input type="checkbox"/>
Floor plate	<input type="checkbox"/>
Seal installation option	<input type="checkbox"/>
Installation opening for on-floor tank	<input type="checkbox"/>
Decouplable	<input type="checkbox"/>
Screed height	215-270 mm
For pipe connection	<input type="checkbox"/>
Suitable for screed-flush closed underfloor ducts	<input type="checkbox"/>
Suitable for screed-covered underfloor ducts	<input checked="" type="checkbox"/>
Suitable for underfloor ducts	<input type="checkbox"/>
Suitable for cavity floor installation	<input type="checkbox"/>

Technical data sheet

Height compensation set for UZD350-3 with height
165–220 mm
Item no. 7410164



Technical data

Suitable for raised floor installation	<input type="checkbox"/>
Duct width	250,00 - 350,00 mm