

Technical data sheet

Series protection device, 4-pole, 48 V version

Item no. 5098452



Lightning barrier for intrinsically safe measuring circuits

- Protection device for multi-wire systems
- Direct shield earthing and screwless connection terminals
- Space-saving width of just 8.7 mm
- High frequency range of 0–100 MHz
- ATEX approval: II 2(1) G Ex ia [ia Ga] IIC T4 (BVS 11 ATEX E 131 X)
- UL-listed (4UM2)

Application: Universal use on 35 mm DIN profile rail in any standard distribution housing.



Dimensions

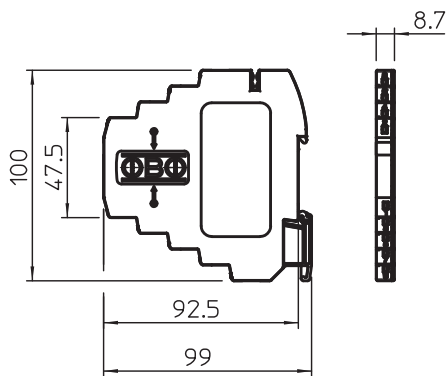

Master data

Item no.	5098452
Type	MDP-4 D-48-EX
Description 1	Lightning barrier
Description 2	for Ex protection applications
Dimension	48V
Colour	Blue
Smallest sales unit (VG)	1 Piece
Weight	5,80 kg/100 pc.

Technical data sheet

Series protection device, 4-pole, 48 V version

Item no. 5098452



Technical data

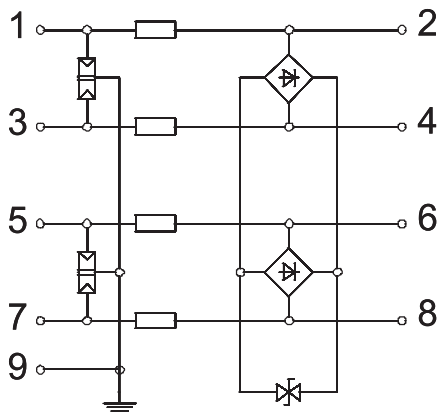

Arrestor monitoring	<input type="checkbox"/>
Category	Type 1+2+3 / D1+C2+C1
SPD to IEC 61643-21	Class I+II+III / D1+C2+C1
Connection cross-section, flexible	0,14 - 2,50 mm ²
Connection cross-section, multi-wire	0,14 - 1,50 mm ²
Connection cross-section, rigid	0,14 - 2,50 mm ²
Number of poles	4
Insertion loss	≤3 dB
Earthing via:	DIN rail
EX approval	II 2(1)G Ex ia [ia Ga] IIC T4 Gb
Telecommunications contact	<input type="checkbox"/>
Total discharge current (8/20)	10 kA
Total discharge current (10/350)	D1: 2 kA
Frequency range	0-100 MHz
Frequency range	0,00 - 100,00 MHz
Cut-off frequency	100,00 MHz
Maximum continuous voltage AC	41,00 V
Maximum continuous voltage DC	58,00 V
Insulation resistance	>100 MΩ
Capacity (wire-wire)	< 40 pF
Lightning protection zone LPZ	0→3
Nominal voltage	48,00 V
Rated current	0,58 A
Nominal load current AC	0,40 A
Nominal load current DC	0,58 A
Installation type	DIN rail
Testing standard	IEC 61643-21
Shielding connection available	Yes
Shield connection	Direct
Protection rating	IP20
Protection level wire-wire	< 95 V
Protection level wire-earth	<800 V
Series resistance per wire	2,35 Ω ± 5 %
Signalling on device	None
Connection system	Terminal
Impulse durability wire-wire	C1: 0,5 KV / 0,25 kA (8/20μs)
Impulse durability wire-earth	C2: 5 KV / 2,5 kA (8/20μs)
Temperature range	-40+80 °C
Approvals	