

Technical data sheet

Earthing clamp, type 942

Item no. 5038081



- For pipes 1/8-1 1/2" or Ø 8-49 mm
- Connection options: Cables up to 25 mm²
- With connection clip and cylinder bolt M6 x 16 made of brass, nickel-plated
- Clamp cover and base made of copper, nickel-plated



Cu	Copper
N	Nickel-plated

Master data

Item no.	5038081
Type	942 28
Description 1	Earthing clamp
Dimension	24-28mm
Material	Copper
Material symbol	Cu
Surface	Nickel-plated
Surface symbol	N
Smallest sales unit (VG)	10 Piece
Weight	6,17 kg/100 pc.

Technical data

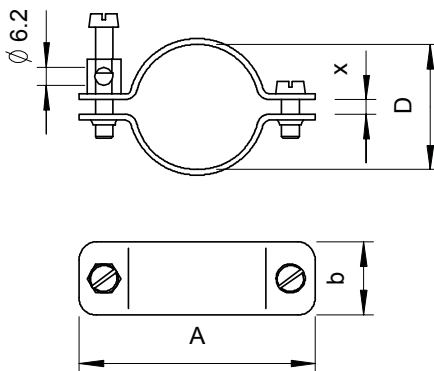

Dimension A	63,00 mm
Dimension X	3,00 mm
Dimension b	20,00 mm
Connection option 1	Cables to 25 mm ²
Number of conductors	1
Cross-section of cable to be connected	0,00 - 25,00 mm ²
for pipe diameter	3/4 inch
Clamping range D	24,00 - 28,00 mm
Clamping range D	3/4 inch