

Technical data sheet

Cable tray SKS-Magic® 60

Item no. 6059462



Cable tray with integrated quick fastening system. The usable length of the cable tray is 3,000 mm.

The cable tray has continuous side perforations of 7 x 20 mm for the installation of additional connection and mounting components.

From a cable tray width of 200 mm with 30% hole surface, suitable for use under sprinkler systems according to VdS guideline 2092.

Continuous equipotential bonding is guaranteed without additional components.

Magnetic shield insulation without cover 20 dB, with cover 50 dB.



St Steel

FS Strip galvanised

Product text, standards

The cable tray is tested for the mounting above suspended fire protection ceilings (tray widths 100–600 mm).
The mounting version and the mounting parameters correspond to the valid certificates.
You can find additional information in our fire protection systems catalogue.

Master data

Item no.	6059462
Type	SKSM 630 FS
Description 1	Cable tray SKSM
Description 2	perforated, quick connector
Manufacturer	OBO
Dimension	60x300x3050
Material	Steel
Material symbol	St
Surface	Strip galvanised
Surface to DIN	DIN EN 10346
Surface symbol	FS
Smallest sales unit (VG)	3 m
Weight	385,25 kg/100 m

Technical data sheet

Cable tray SKS-Magic® 60

Item no. 6059462



Technical data



Usable cross-section	17.800,00 mm ²
Usable cross-section	178,00 cm ²
Suitable for maintaining electrical function	<input type="checkbox"/>
Connector version	Integrated connector
With cover	<input type="checkbox"/>
Mounting perforation in base	<input checked="" type="checkbox"/>
NATO hole pattern	<input type="checkbox"/>
Rustproof steel, pickled	<input type="checkbox"/>
Side perforation	<input checked="" type="checkbox"/>
Wide-span version	<input type="checkbox"/>

Dimensions

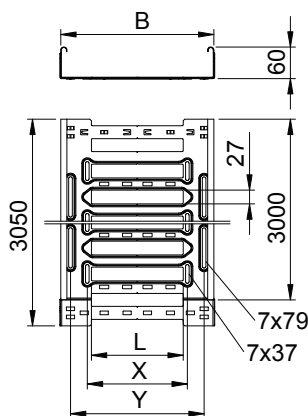

Length	3.050,00 mm
Width	300,00 mm
Height	60,00 mm
Side height	60,00 mm
Dimension B	300,00 mm
Dimension L	180,00 mm
Dimension x	196,00 mm
Dimension y	262,00 mm
Plate thickness	1,50 mm

Appr. load:

Support spacing 1.5 m	2,70 kN/m
Support spacing 2.0 m	2,10 kN/m
Support spacing 2.5 m	1,47 kN/m
Support spacing 3.0 m	0,80 kN/m

Load diagram, cable tray, type SKSM 60

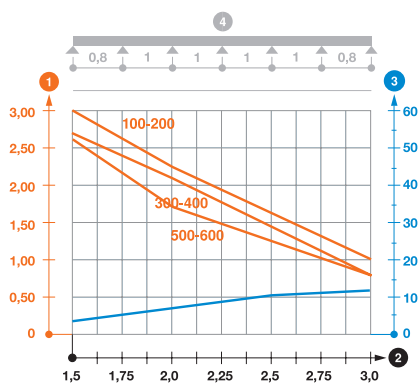

- 1 Permitted cable tray/ladder load in kN/m without man load
- 2 Support width in m
- 3 Rail bend in mm at permitted kN/m
- 4 Load scheme during testing
- Load curve with cable tray/ladder width in mm
- Strut bend curve according to support width