

Technical data sheet

Cable tray SKS-Magic® 110

Item no. 6059624

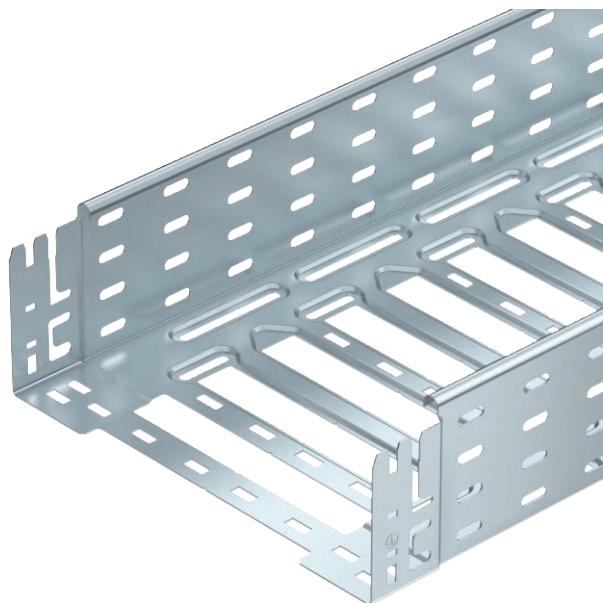

Cable tray with integrated quick fastening system. The usable length of the cable tray is 3,000 mm.

The cable tray has continuous side perforations of 7 x 20 mm for the installation of additional connection and mounting components.

From a cable tray width of 200 mm with 30% hole surface, suitable for use under sprinkler systems according to VdS guideline 2092.

Continuous equipotential bonding is guaranteed without additional components.



St Steel

FS Strip galvanised

Master data

Item no.	6059624
Type	SKSM 150 FS
Description 1	Cable tray SKSM
Description 2	perforated, quick connector
Manufacturer	OBO
Dimension	110x500x3050
Material	Steel
Material symbol	St
Surface	Strip galvanised
Surface to DIN	DIN EN 10346
Surface symbol	FS
Smallest sales unit (VG)	3 m
Weight	602,95 kg/100 m

Technical data

	Usable cross-section	54.800,00 mm ²
	Usable cross-section	548,00 cm ²
	Suitable for maintaining electrical function	<input type="checkbox"/>
	Connector version	Integrated connector
	With cover	<input type="checkbox"/>
	Mounting perforation in base	<input checked="" type="checkbox"/>
	NATO hole pattern	<input type="checkbox"/>
	Rustproof steel, pickled	<input type="checkbox"/>
	Side perforation	<input checked="" type="checkbox"/>
Wide-span version	<input type="checkbox"/>	

Technical data sheet

Cable tray SKS-Magic® 110

Item no. 6059624



Technical data

Dimensions

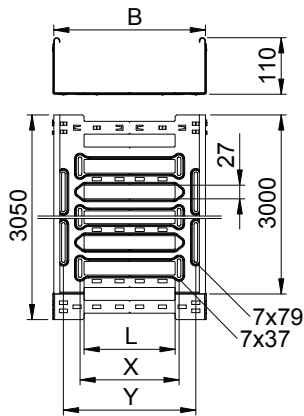

Length	3.050,00 mm
Width	500,00 mm
Height	110,00 mm
Side height	110,00 mm
Dimension B	500,00 mm
Dimension L	380,00 mm
Dimension x	396,00 mm
Dimension y	462,00 mm
Plate thickness	1,50 mm

Appr. load:

Support spacing 1.5 m	3,00 kN/m
Support spacing 2.0 m	2,34 kN/m
Support spacing 2.5 m	1,74 kN/m
Support spacing 3.0 m	1,20 kN/m
Support spacing 3.5 m	0,72 kN/m
Support spacing 4.0 m	0,30 kN/m

Load diagram, cable tray, type SKSM 110

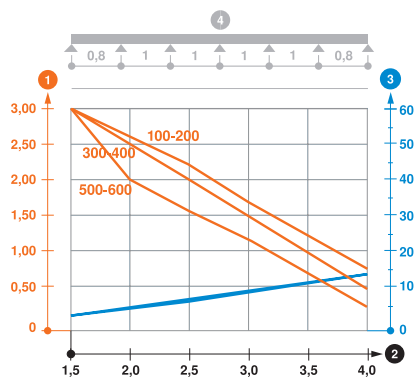

- 1 Permitted cable tray/ladder load in kN/m without man load
- 2 Support width in m
- 3 Rail bend in mm at permitted kN/m
- 4 Load scheme during testing
- Load curve with cable tray/ladder width in mm
- Strut bend curve according to support width