

# Technical data sheet

## Cable tray SKS-Magic® 110

Item no. 6059618

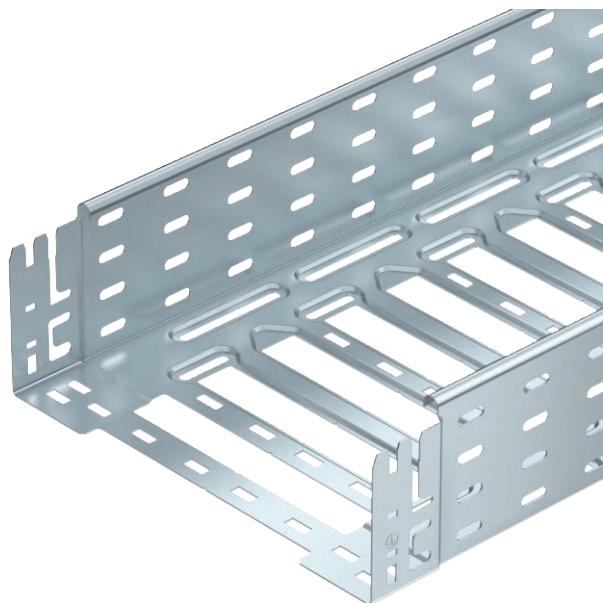

Cable tray with integrated quick fastening system. The usable length of the cable tray is 3,000 mm.

The cable tray has continuous side perforations of 7 x 20 mm for the installation of additional connection and mounting components.

From a cable tray width of 200 mm with 30% hole surface, suitable for use under sprinkler systems according to VdS guideline 2092.

Continuous equipotential bonding is guaranteed without additional components.



**St** Steel

**FS** Strip galvanised

### Master data

Item no.	6059618
Type	SKSM 120 FS
Description 1	Cable tray SKSM
Description 2	perforated, quick connector
Manufacturer	OBO
Dimension	110x200x3050
Material	Steel
Material symbol	St
Surface	Strip galvanised
Surface to DIN	DIN EN 10346
Surface symbol	FS
Smallest sales unit (VG)	3 m
Weight	434,75 kg/100 m

### Technical data

	Usable cross-section	21.800,00 mm <sup>2</sup>
	Usable cross-section	218,00 cm <sup>2</sup>
	Suitable for maintaining electrical function	<input type="checkbox"/>
	Connector version	Integrated connector
	With cover	<input type="checkbox"/>
	Mounting perforation in base	<input checked="" type="checkbox"/>
	NATO hole pattern	<input type="checkbox"/>
	Rustproof steel, pickled	<input type="checkbox"/>
	Side perforation	<input checked="" type="checkbox"/>
	Wide-span version	<input type="checkbox"/>

# Technical data sheet

## Cable tray SKS-Magic® 110

Item no. 6059618



### Technical data

#### Dimensions

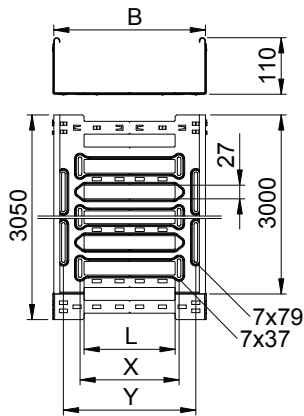

Length	3.050,00 mm
Width	200,00 mm
Height	110,00 mm
Side height	110,00 mm
Dimension B	200,00 mm
Dimension L	80,00 mm
Dimension x	96,00 mm
Dimension y	162,00 mm
Plate thickness	1,50 mm

#### Appr. load:

Support spacing 1.5 m	3,00 kN/m
Support spacing 2.0 m	2,57 kN/m
Support spacing 2.5 m	2,14 kN/m
Support spacing 3.0 m	1,70 kN/m
Support spacing 3.5 m	1,25 kN/m
Support spacing 4.0 m	0,80 kN/m

Load diagram, cable tray, type SKSM 110

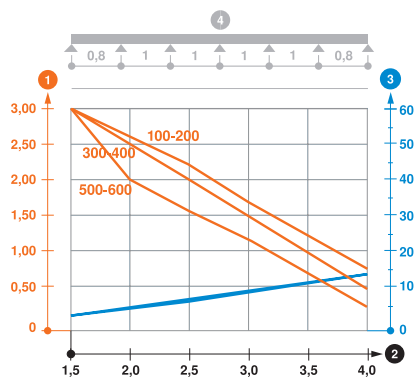

- 1 Permitted cable tray/ladder load in kN/m without man load
- 2 Support width in m
- 3 Rail bend in mm at permitted kN/m
- 4 Load scheme during testing
- Load curve with cable tray/ladder width in mm
- Strut bend curve according to support width