

Technical data sheet

Cable tray SKS-Magic® 110, unperforated

Item no. 6059840

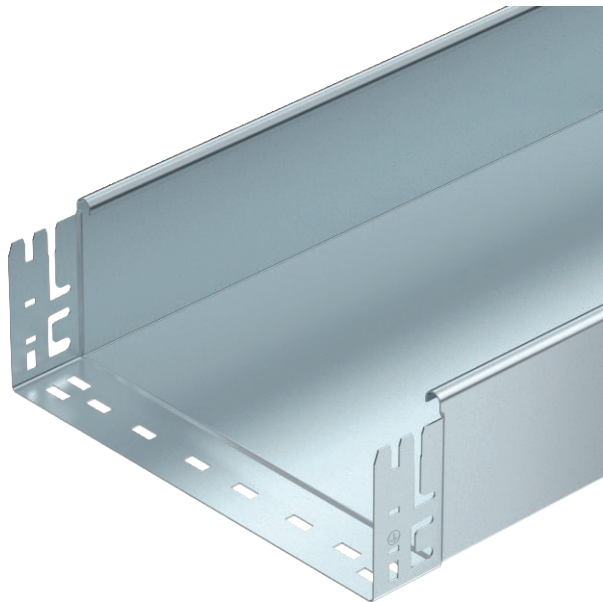

Unperforated cable tray with integrated quick fastening system. The usable length of the cable tray is 3,000 mm.

Continuous equipotential bonding is guaranteed without additional components.



St Steel

FS Strip galvanised

Master data

Item no.	6059840
Type	SKSMU 120 FS
Description 1	Cable tray SKSMU
Description 2	unperforated, quick connector
Manufacturer	OBO
Dimension	110x200x3050
Material	Steel
Material symbol	St
Surface	Strip galvanised
Surface to DIN	DIN EN 10346
Surface symbol	FS
Smallest sales unit (VG)	3 m
Weight	521,80 kg/100 m

Technical data

	Usable cross-section	21.800,00 mm ²
	Usable cross-section	218,00 cm ²
	Suitable for maintaining electrical function	<input type="checkbox"/>
	Connector version	Integrated connector
	With cover	<input type="checkbox"/>
	Mounting perforation in base	<input type="checkbox"/>
	NATO hole pattern	<input type="checkbox"/>
	Rustproof steel, pickled	<input type="checkbox"/>
	Side perforation	<input type="checkbox"/>
Wide-span version	<input type="checkbox"/>	

Technical data sheet

Cable tray SKS-Magic® 110, unperforated

Item no. 6059840



Technical data

Dimensions

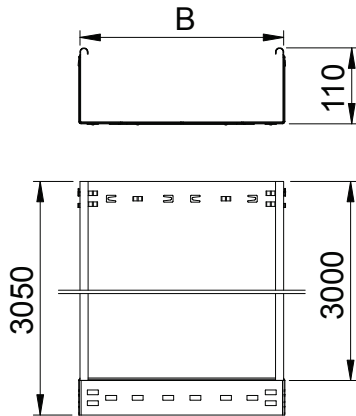

Length	3.050,00 mm
Width	200,00 mm
Height	110,00 mm
Side height	110,00 mm
Dimension B	200,00 mm
Plate thickness	1,50 mm

Appr. load:

Support spacing 1.5 m	3,00 kN/m
Support spacing 2.0 m	2,40 kN/m
Support spacing 2.5 m	1,76 kN/m
Support spacing 3.0 m	1,20 kN/m
Support spacing 3.5 m	0,84 kN/m
Support spacing 4.0 m	0,80 kN/m

Load diagram, cable tray, type SKSMU 110

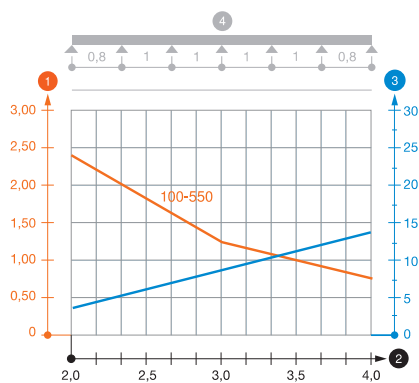

- 1 Permitted cable tray/ladder load in kN/m without man load
- 2 Support width in m
- 3 Rail bend in mm at permitted kN/m
- 4 Load scheme during testing
- Load curve with cable tray/ladder width in mm
- Strut bend curve according to support width