

Technical data sheet

90° adjustable bend, vertical 60

Item no. 7079508

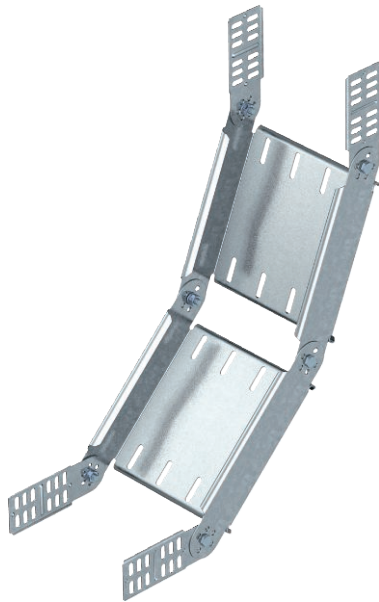

90° adjustable vertical bend, for all cable tray types with a side height of 60 mm.

The bend is shipped in an unmounted state. No additional fastening materials are required.



St Steel

FT Hot-dip galvanised

Master data

Item no.	7079508
Type	RGBV 650 FT
Description 1	Adjustable bend
Description 2	vertical
Dimension	60x500
Material	Steel
Material symbol	St
Surface	Hot-dip galvanised
Surface to DIN	DIN EN ISO 1461
Surface symbol	FT
Smallest sales unit (VG)	1 Piece
Weight	404,00 kg/100 pc.

Technical data

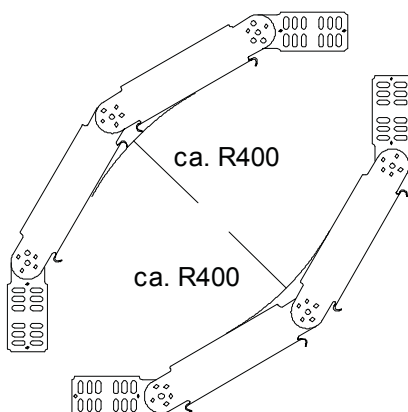

Width	500,00 mm
Side height	60,00 mm
Dimension R	400,00 mm
Connector version	Supplied connectors
Shape	Articulated bend, complete
Plate thickness	1,00 mm
Suitable for maintaining electrical function	<input type="checkbox"/>
Mounting perforation in base	<input type="checkbox"/>
NATO hole pattern	<input type="checkbox"/>
Rustproof steel, pickled	<input type="checkbox"/>
Side perforation	<input type="checkbox"/>
Wide-span version	<input type="checkbox"/>