

Technical data sheet

Adjustable bend element, vertical 60

Item no. 7075154

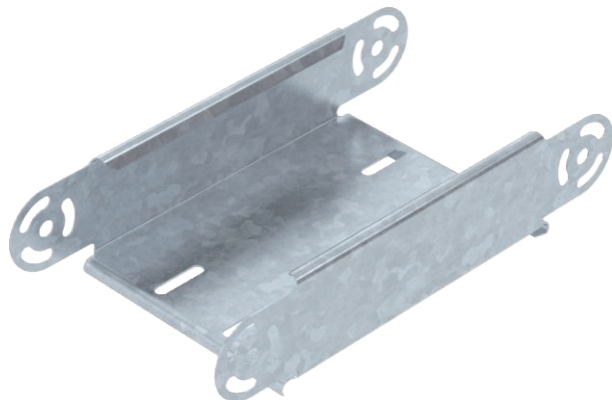

Adjustable vertical bend element, for all cable tray types with a side height of 60 mm.

RGV 60 adjustable connectors should be ordered separately and in the appropriate quantity.



St	Steel
FT	Hot-dip galvanised

Product text, scope of delivery | RGV 60 and SKS 8x16 hexagonal bolts should be ordered separately.

Master data

Item no.	7075154
Type	RGBEV 615 FT
Description 1	Adjustable bend element
Description 2	vertical
Dimension	60x150
Material	Steel
Material symbol	St
Surface	Hot-dip galvanised
Surface to DIN	DIN EN ISO 1461
Surface symbol	FT
Smallest sales unit (VG)	1 Piece
Weight	60,30 kg/100 pc.

Technical data

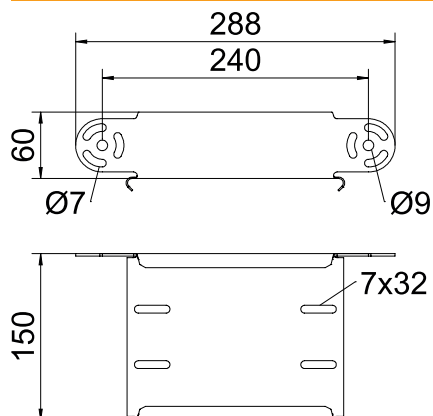

Width	150,00 mm
Side height	60,00 mm
Connector version	Without connectors
Shape	Articulated bend element
Plate thickness	1,00 mm
Dimension	288 x 150 x 60 mm
Suitable for maintaining electrical function	<input type="checkbox"/>
Mounting perforation in base	<input type="checkbox"/>
NATO hole pattern	<input type="checkbox"/>
Rustproof steel, pickled	<input type="checkbox"/>
Side perforation	<input type="checkbox"/>
Wide-span version	<input type="checkbox"/>