

# Technical data sheet

## 90° vertical bend, rising 60

Item no. 7007022

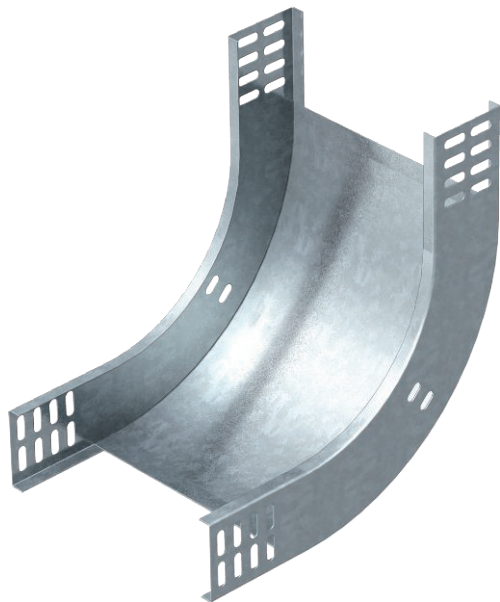

90° rising vertical bend, for all cable tray types of 60 mm side height.

The vertical bend is pushed over the end of the cable tray and screwed tight. Fastening materials should be ordered separately.



- St** Steel
- FT** Hot-dip galvanised

### Master data

Item no.	7007022
Type	RBV 640 S FT
Description 1	90° vertical bend
Description 2	rising
Dimension	60x400
Material	Steel
Material symbol	St
Surface	Hot-dip galvanised
Surface to DIN	DIN EN ISO 1461
Surface symbol	FT
Smallest sales unit (VG)	1 Piece
Weight	163,00 kg/100 pc.

### Technical data

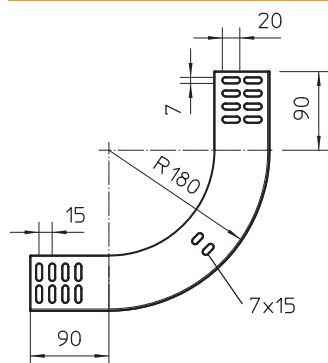

Width	400,00 mm
Side height	60,00 mm
Dimension B	400,00 mm
Bend (angle)	90°
Connector version	Without connectors
Plate thickness	1,00 mm
Suitable for maintaining electrical function	<input type="checkbox"/>
Mounting perforation in base	<input type="checkbox"/>
NATO hole pattern	<input type="checkbox"/>
Change of direction	Vertical rising
Rustproof steel, pickled	<input type="checkbox"/>
Side perforation	<input type="checkbox"/>
Wide-span version	<input type="checkbox"/>